

gtsa.com.tr



CALIPER REPAIR KITS



KNR | MRT | WBC | HDX
BV | SF | Z-CM | IVC

GSA / automotive

**THE SAME QUALITY,
THE SAME PROFESSIONALITY
ALL OVER THE WORLD**

Quality defying years with more than 40 years of production and experience.



ABOUT US

Muammer Geçgel, one of the founders of Geçgel Makine, which was established in Konya to manufacture machine tools in 1981. Founded "Turbotek Automotive company in 2012". Since the day it was inaugurated, it has become one of the leading companies in its sector by increasing quality with the necessary investments and right choices.

With its R&D structure and engineering studies, it operates to reach the highest level in brake equipment of commercial vehicles. Our company which exports 60% of its products to more than 65 countries, mainly OEM and OES companies, strengthens its place in the sector day by day with its wide marketing network and aims to become one of the leading companies in the world in suspension systems and brake equipment.

Today, Turbotek, which serves in its factory with 9000 m2 closed and 10000 m2 open area in Konya Organized Industrial Zone, creates a definite fierce advantage in the markets with its particular factors from other companies in the sector:

Features that distinguish Turbotek from its competitors:

- Short delivery time due to the wide variety in the product portfolio and the high rate of fulfilling orders from stock
- Dominating our sector with the most advanced quality understanding, expert production staff of each sub-part of the product, due to conception 90% of products in its portfolio.
- Having a global price competitive advantage as the result of our flexibility, our experiences and through our latest integrated technology and its high-scale production.
- While carrying out innovated design and production activities in its central 10,000 m² production facility, it produces OEM quality products with the international standard and quality norms.
- Seeking a competitive position in the world in OEM, OES and aftermarket, with its experienced staff in product development and quality controls, technological laboratory and advanced equipment.



Quality



index

KNR

6-61

SB5	8
SN5	16
SB6..SB7	18
SB7 RADIAL	38
SN6..SN7..SK7.....	41
SL7..SM7..ST7	55

MRT

62-139

ELSA 2	64
ELSA195 - ELSA225 - EX225 .	76
ELSA 1	83
DX195	93
DX225	101
DUCO	107
LISA	121
D3	127

WBC

140-178

PAN 17	142
19,5"/ 22,5" Single Piston.....	149
19,5"/ 22,5" Double Piston.....	155
MAXX 17	161
MAXX 22	165
MAXX 22L	170
MAXX 22T	175

HDX

179-203

MARK II /III/IV	179
MODUL X GEN1 GEN2	193

BV

204-213

SF

214-221

IVC

222-241

Ø381/394 DUPLEX	224
Ø410 DUPLEX	227
Ø410 SIMPLEX	231
Ø360 PERROT	235
Ø410 PERROT	239

Z-CM

242-249



KNR

GTK1.957 Caliper Pin Repair Kit



OEM NO: I1369100062 - I1339680062 - MB 000 420 1282 - MN 8150822.6009 - SCN 1390427 - 2121643 - DF 1142142 - 1198153 - 1198154 - 1448915 - IVECO 93162048 - NPLN 11015565

VEHICLE: MB ATEGO 712>>1023 - MAN TGL 12.160)- GIGANT Axle 98 >> 00

NR	GTSA KOD	DESCRIPTION	QTY
1	151.05	Caliper Pin - Ø36x145 mm	1
2	151.02	Caliper Pin - Ø34x80 mm	1
3	155.05	Caliper Pin Bolt - M16x1,50x150 mm	1
4	155.02.02	Caliper Pin Bolt - M16x1,50x85 mm	1
5	161.01	Caliper Pin Bush - Ø40xØ36x82 mm	1
6	165.07	Caliper Pin Rubber Bush - Ø40xØ34x50 mm	1
7	165.05	Caliper Pin Boot	1
8	165.08	Caliper Pin Boot Ring	1
9	165.06	Caliper Pin Bellow Cap	1
10	191.01	Caliper Pin Bellow Cap Clamp	1
11	165.25	Caliper Cover Seal	1

GTK1.959 Caliper Long Pin Repair Kit



OEM NO: K000935

VEHICLE:

NR	GTSA KOD	DESCRIPTION	QTY
1	151.05	Caliper Pin - Ø36x145 mm	1
2	155.05	Caliper Pin Bolt - M16x1,50x150 mm	1
3	161.01	Caliper Pin Bush - Ø40xØ36x82 mm	1
4	165.05	Caliper Pin Boot	1
5	165.08	Caliper Pin Boot Ring	1
6	165.06	Caliper Pin Bellow Cap	1
7	191.01	Caliper Pin Bellow Cap Clamp	1

GTK1.961 Caliper Short Pin Repair Kit



OEM NO: I1368470064

VEHICLE:

NR	GTSA KOD	DESCRIPTION	QTY
1	151.02	Caliper Pin - Ø34x80 mm	1
2	155.02.02	Caliper Pin Bolt - M16x1,50x85 mm	1
3	165.07	Caliper Pin Rubber Bush - Ø40xØ34x50 mm	1

KNR

SB5

GTK1.912 Caliper Pin & Boot Set

OEM NO

VEHICLE

NR	GTSA KOD	DESCRIPTION	QTY
1	168.06	Caliper Thrust Part With Bellow - Ø74 mm	1
2	165.03	Caliper Shaft Housing Boot - Ø74 mm	1
3	161.02	Caliper Tappet Bush - Ø16xØ18x10 mm	1
4	165.07	Caliper Pin Rubber Bush - Ø40xØ34x50 mm	1
5	165.05	Caliper Pin Boot	1
6	165.08	Caliper Pin Boot Ring	1
7	165.06	Caliper Pin Bellow Cap	1
8	191.01	Caliper Pin Bellow Cap Clamp	1

GTK1.9024 Caliper Pin Boot & Cap Set

OEM NO 11350470061

VEHICLE

NR	GTSA KOD	DESCRIPTION	QTY
1	165.05	Caliper Pin Boot	1
2	165.08	Caliper Pin Boot Ring	1
3	165.06	Caliper Pin Bellow Cap	1
4	191.01	Caliper Pin Bellow Cap Clamp	1

GTK1.904 Caliper Short Pin Repair Kit

Ø 34 x 80 mm

NR	GTSA KOD	DESCRIPTION	QTY
1	151.02	Caliper Pin - Ø34x80 mm	1
2	165.07	Caliper Pin Rubber Bush - Ø40xØ34x50 mm	1

GTK1.908 Caliper Shaft Housing Set

NR	GTSA KOD	DESCRIPTION	QTY
1	1908	Shaft Housing	1
2	191.08	Spring - Ø21x51,50 mm	2

GTK1.902

Caliper Tappet & Boot Set Ø74 mm



OEM NO 11370760065

VEHICLE MB ATEGO 712 >> 1023 - MAN TGL (12.160) - GIGANT Axle 98>> (00)

NR	GTSA KOD	DESCRIPTION	QTY
1	168.06	Caliper Thrust Part With Bellow - Ø74 mm	1
2	165.03	Caliper Shaft Housing Boot - Ø74 mm	1
3	161.02	Caliper Tappet Bush - Ø16xØ18x10 mm	1

GTK1.911-1

Caliper Adjusting Mechanism Shaft Chain (12 Links)



OEM NO

VEHICLE

GTK1.905

Caliper Support Seal Set



NR	GTSA KOD	DESCRIPTION	QTY
1	165.29	Caliper Support Seal	5

GTK1.945

Caliper Needle Bearing Set



NR	GTSA KOD	DESCRIPTION	QTY
1	181.02	Caliper Needle Bearing	2

GTK1.978

Caliper Lever



OEM NO

VEHICLE

GTK1.910

Caliper Adjusting Mechanism Shaft



OEM NO

VEHICLE

KNR

SB5

GTK1.996

Caliper Pinion Shaft



OEM NO

VEHICLE

GTK1.907

Caliper Calibration Bolt



OEM NO

VEHICLE

GTK1.9012

Caliper Plastic Cover (Without Sensor)



OEM NO

VEHICLE

MB ATEGO 712>> (1023) - MAN TGL (12.160) - GIGANT Axle 98>> (00)

GTK1.9013

Caliper Plastic Cover (2 Wires Sensor)



OEM NO

VEHICLE

MB ATEGO 712>> (1023)

GTK1.9046

Caliper Plastic Cover (3 Wires Sensor)



OEM NO

VEHICLE

MB ATEGO 712 (1023)

GTK1.9027

Caliper Plastic Cover (3 Wires Sensor) - MAN



OEM NO

VEHICLE

MAN TGL (12.160)

SK1001

Caliper Complete Repair Kit



VEHICLE MB ATEGO 712>> (1023) - MAN TGL (12.160) - GIGANT Axle 98 >> (00)

NR	GTSA KOD	DESCRIPTION	QTY	NR	GTSA KOD	DESCRIPTION	QTY
1	GTK1.957	Caliper Pin Repair Kit	1	6	GTK1.945	Caliper Needle Bearing Set	1
2	GTK1.902	Caliper Tappet & Boot Set $\varnothing 74$ mm	1	7	GTK1.910	Caliper Adjusting Mechanism Shaft	1
3	GTK1.991	Caliper Cap Set	1	8	GTK1.996	Caliper Pinion Shaft	1
4	GTK1.907	Caliper Calibration Bolt	1	9	GTK1.911-1	Caliper Adjusting Mechanism Shaft Chain (12 Links)	1
5	GTK1.908	Caliper Shaft Housing Set	1				

SK1019

Caliper Complete Repair Kit



VEHICLE MB ATEGO 712>> (1023) - MAN TGL (12.160) - GIGANT Axle 98 >> (00)

NR	GTSA KOD	DESCRIPTION	QTY	NR	GTSA KOD	DESCRIPTION	QTY
1	GTK1.957	Caliper Pin Repair Kit	1	6	GTK1.978	Caliper Lever	1
2	GTK1.902	Caliper Tappet & Boot Set $\varnothing 74$ mm	1	7	GTK1.945	Caliper Needle Bearing Set	1
3	GTK1.991	Caliper Cap Set	1	8	GTK1.910	Caliper Adjusting Mechanism Shaft	1
4	GTK1.907	Caliper Calibration Bolt	1	9	GTK1.996	Caliper Pinion Shaft	1
5	GTK1.908	Caliper Shaft Housing Set	1	10	GTK1.911-1	Caliper Adjusting Mechanism Shaft Chain (12 Links)	1

KNR

SN5

GTK1.915 Caliper Pin Repair Kit	
OEM NO	K001928
VEHICLE	MB ATEGO 712>> (1023) - MAN TGL (12.180)

NR	GTSA KOD	DESCRIPTION	QTY
1	151.10	Caliper Pin - Ø30x99 mm	1
2	151.11	Caliper Pin - Ø30x72 mm	1
3	155.08	Caliper Pin Bolt - M16x1,50x105 mm	1
4	155.07.01	Caliper Pin Bolt - M16x1,50x75 mm	1
5	165.21	Caliper Pin Boot	2
6	165.22	Caliper Pin Boot Ring	2
7	161.04	Caliper Pin Bush - Ø34xØ30x65 mm	1
8	161.07	Caliper Pin Bush - Ø34xØ30x20 mm	1
9	171.05	Caliper Pin Cap -Ø34x14 mm	2

GTK1.900 Caliper Tappet & Boot Set	
OEM NO	K001928
VEHICLE	MB ATEGO 712 (1023) - MAN TGL (12.180)

NR	GTSA KOD	DESCRIPTION	QTY
1	168.05	Caliper Thrust Part With Bellow - Ø69 mm	1
2	161.02	Caliper Tappet Bush - Ø18xØ16x10	1

GTK1.900-1 Caliper Tappet & Boot Set	
OEM NO	K001928
VEHICLE	MB ATEGO 712>> (1023) - MAN TGL (12.180)

NR	GTSA KOD	DESCRIPTION	QTY
1	168.05	Caliper Thrust Part With Bellow - Ø69 mm	1
2	165.01	Caliper Shaft Housing Boot - Ø69 mm	1
3	161.02	Caliper Tappet Bush - Ø18xØ16x10	1

GTK1.948 Caliper Adjusting Mechanism Cap Set



OEM NO	K000029
VEHICLE	

NR	GTSA KOD	DESCRIPTION	QTY
1	165.13	Caliper Adjusting Mechanism Cap - Ø38 mm	10
2	191.03	Caliper Adjusting Mechanism Adapter	10

GTK1.913 Caliper Needle Bearing Set



NR	GTSA KOD	DESCRIPTION	QTY
1	181.01	Caliper Needle Bearing	2

GTK1.909 Caliper Shaft Housing Set



NR	GTSA KOD	DESCRIPTION	QTY
1	1.909	Shaft Housing	1
2	191.08	Spring - Ø21x51,50 mm	2

GTK1.992 Caliper Cover Set



NR	GTSA KOD	DESCRIPTION	QTY
1	1.992	Caliper Cover	1
2	455.02	Caliper Bolt - M8x16	6

GTK1.9009 Caliper Cover Seal Set



NR	GTSA KOD	DESCRIPTION	QTY
1	165.25	Caliper Cover Seal	5

KNR

SN5

GTK1.910

Caliper Adjusting Mechanism Shaft



OEM NO

VEHICLE

GTK1.994

Caliper Pinion Shaft



OEM NO

VEHICLE

GTK1.911

Caliper Adjusting Mechanism Shaft Chain (14 Links)



OEM NO

VEHICLE

GTK1.907

Caliper Calibration Bolt



OEM NO

VEHICLE

GTK1.979

Caliper Lever



OEM NO

VEHICLE

GTK1.951

Brake Pad Retainer Repair Kit



OEM NO

K000133 - I119712004 - I130679004

VEHICLE

GTK1.995

Caliper Plastic Cover (Without Sensor)



OEM NO

VEHICLE

MB ATEGO 712>> (1023) - MAN TGL (12.180)

GT1.993

Caliper Plastic Cover (2 Wires Sensor)



OEM NO

VEHICLE

MB ATEGO 712>> (1023)

GTK1.935

Caliper Plastic Cover (3 Wires Sensor)



OEM NO

VEHICLE

MB ATEGO 712>> (1023)

GTK1.9047

Caliper Plastic Cover (3 Wires Sensor) - MAN



OEM NO

VEHICLE

MAN TGL (12.180)

KNR

SN5

SK1002

Caliper Complete Repair Kit



VEHICLE MB ATEGO 712>> (1023) - MAN TGL (12.180)

NR	GTSA KOD	DESCRIPTION	QTY	NR	GTSA KOD	DESCRIPTION	QTY
1	GTK1.915	Caliper Pin Repair Kit	1	6	GTK1.913	Caliper Needle Bearing Set	1
2	GTK1.900-1	Caliper Tappet & Boot Set Ø74 mm	1	7	GTK1.910	Caliper Adjusting Mechanism Shaft	1
3	GTK1.992	Caliper Cover Set	1	8	GTK1.994	Caliper Pinion Shaft	1
4	GTK1.907	Caliper Calibration Bolt	1	9	GTK1.911	Caliper Adjusting Mechanism Shaft Chain (14 Links)	1
5	GTK1.909	Caliper Shaft Housing Set	1	10	165.25	Caliper Cover Seal	1

SK1020

Caliper Complete Repair Kit



VEHICLE MB ATEGO 712>> (1023) - MAN TGL (12.180)

NR	GTSA KOD	DESCRIPTION	QTY	NR	GTSA KOD	DESCRIPTION	QTY
1	GTK1.915	Caliper Pin Repair Kit	1	6	GTK1.979	Caliper Lever	1
2	GTK1.900-1	Caliper Tappet & Boot Set Ø74 mm	1	7	GTK1.913	Caliper Needle Bearing Set	1
3	GTK1.992	Caliper Cover Set	1	8	GTK1.910	Caliper Adjusting Mechanism Shaft	1
4	GTK1.907	Caliper Calibration Bolt	1	9	GTK1.994	Caliper Pinion Shaft	1
5	GTK1.909	Caliper Shaft Housing Set	1	10	GTK1.911	Caliper Adjusting Mechanism Shaft Chain (14 Links)	1

GTK1.957 Caliper Pin Repair Kit

1- $\varnothing 36 \times 145$ mm
2- $\varnothing 34 \times 80$ mm
3- 150 mm
4- 85 mm

OEM NO: II369100062 - II339680062

VEHICLE: SAF Axle 19.5"/22.5 - SMB Axle 19.5"/22.5 - MB Axle 22.5" - BPW Axle 19.5" - MB ECONIC - SCANIA 4 Series

NR	GTSA KOD	DESCRIPTION	QTY
1	151.05	Caliper Pin - $\varnothing 36 \times 145$ mm	1
2	151.02	Caliper Pin - $\varnothing 34 \times 80$ mm	1
3	155.04	Caliper Pin Bolt - M16x1,50x150 mm	1
4	155.02.02	Caliper Pin Bolt - M16x1,50x85 mm	1
5	161.01	Caliper Pin Bush - $\varnothing 40 \times \varnothing 36 \times 82$ mm	1
6	165.07	Caliper Pin Rubber Bush - $\varnothing 40 \times \varnothing 34 \times 50$ mm	1
7	165.05	Caliper Pin Boot	1
8	165.08	Caliper Pin Boot Ring	1
9	165.06	Caliper Pin Bellow Cap	1
10	191.01	Caliper Pin Bellow Cap Clamp	1

GTK1.959 Caliper Long Pin Repair Kit

2- 150 mm
1- $\varnothing 36 \times 145$ mm

OEM NO: K000935

VEHICLE:

NR	GTSA KOD	DESCRIPTION	QTY
1	151.05	Caliper Pin - $\varnothing 36 \times 145$ mm	1
2	155.04	Caliper Pin Bolt - M16x1,50x150 mm	1
3	161.01	Caliper Pin Bush - $\varnothing 40 \times \varnothing 36 \times 82$ mm	1
4	165.05	Caliper Pin Boot	1
5	165.08	Caliper Pin Boot Ring	1
6	165.06	Caliper Pin Bellow Cap	1
7	191.01	Caliper Pin Bellow Cap Clamp	1

GTK1.958 Caliper Pin Repair Kit

3- 140 mm
4- 85 mm
1- $\varnothing 36 \times 135$ mm
2- $\varnothing 34 \times 80$ mm

OEM NO: K000132 - II350470062

VEHICLE: MB ATEGO 1220 (1528) - MB ECONIC - SCANIA 4 Series - SCANIA BUS 4 Series

NR	GTSA KOD	DESCRIPTION	QTY
1	151.04	Caliper Pin - $\varnothing 36 \times 135$ mm	1
2	151.02	Caliper Pin - $\varnothing 34 \times 80$ mm	1
3	155.03	Caliper Pin Bolt - M16x1,50x140 mm	1
4	155.02.02	Caliper Pin Bolt - M16x1,50x85 mm	1
5	161.01	Caliper Pin Bush - $\varnothing 40 \times \varnothing 36 \times 82$ mm	1
6	165.07	Caliper Pin Rubber Bush - $\varnothing 40 \times \varnothing 34 \times 50$ mm	1
7	165.05	Caliper Pin Boot	1
8	165.08	Caliper Pin Boot Ring	1
9	165.06	Caliper Pin Bellow Cap	1
10	191.01	Caliper Pin Bellow Cap Clamp	1

KNR

SB6..SB7

GTK1.961 Caliper Short Pin Repair Kit	
	
OEM NO	I1368470064
VEHICLE	

NR	GTSA KOD	DESCRIPTION	QTY
1	151.02	Caliper Pin - Ø34x80 mm	1
2	155.02.02	Caliper Pin Bolt - M16x1,50x85 mm	1
3	165.07	Caliper Pin Rubber Bush - Ø40xØ34x50 mm	1

GTK1.904 Caliper Short Pin Repair Kit	
	
OEM NO	
VEHICLE	

NR	GTSA KOD	DESCRIPTION	QTY
1	151.02	Caliper Pin - Ø34x80 mm	1
2	165.07	Caliper Pin Rubber Bush - Ø40xØ34x50 mm	1

GTK1.9024 Caliper Pin Boot & Cap Set	
	
OEM NO	I1350470061
VEHICLE	

NR	GTSA KOD	DESCRIPTION	QTY
1	165.05	Caliper Pin Boot	1
2	165.08	Caliper Pin Boot Ring	1
3	165.06	Caliper Pin Bellow Cap	1
4	191.01	Caliper Pin Bellow Cap Clamp	1

GTK1.9022 Caliper Pin Repair Kit

OEM NO: K067417K50

VEHICLE: MAN TGA - IVECO EUROARGO - IVECO EUROTRAKKER - IVECO EUROSTAR - IVECO EUROTCH - IVECO STRALIS - BPW Axle - SAF Axle

NR	GTSA KOD	DESCRIPTION	QTY
1	151.03	Caliper Pin - Ø36x114 mm	1
2	151.01	Caliper Pin - Ø32x80 mm	1
3	155.02.02	Caliper Pin Bolt - M16x1,50x85 mm	1
4	155.01.01	Caliper Pin Bolt - M16x1,50x80 mm	1
5	161.01	Caliper Pin Bush - Ø40xØ36x82 mm	1
6	165.11	Caliper Pin Rubber Bush - Ø39 mm	1
7	161.06	Rubber Bush Stop Ring - Ø35 mm	1
8	175.01	Caliper Pin Bolt Ring - Ø26x11,50 mm	1
9	165.05	Caliper Pin Boot	1
10	165.08	Caliper Pin Boot Ring	1
11	171.04	Caliper Pin Cap - Ø40x14,50 mm	1
12	171.02	Caliper Pin Cap - Ø54x28 mm	1
13	191.02	Caliper Pin Cap Oring	1

GTK1.9021 Caliper Pin Repair Kit

OEM NO: K000365

VEHICLE:

NR	GTSA KOD	DESCRIPTION	QTY
1	151.03	Caliper Pin - Ø36x114 mm	1
2	151.01	Caliper Pin - Ø32x80 mm	1
3	151.02	Caliper Pin - Ø34x80 mm	1
4	155.02.02	Caliper Pin Bolt - M16x1,50x85 mm	2
5	155.01.01	Caliper Pin Bolt - M16x1,50x80 mm	1
6	161.01	Caliper Pin Bush - Ø40xØ36x82 mm	1
7	165.07	Caliper Pin Rubber Bush - Ø40xØ34x50 mm	1
8	165.10	Caliper Pin Rubber Bush - Ø39 mm (Short)	1
9	165.05	Caliper Pin Boot	1
10	165.08	Caliper Pin Boot Ring	1
11	171.04	Caliper Pin Cap - Ø40x14,50 mm	1
12	171.02	Caliper Pin Cap - Ø54x28 mm	1
13	191.02	Caliper Pin Cap Oring	1

GTK1.973 Caliper Pin Repair Kit

OEM NO: K031844K50 - K01117

VEHICLE: SCANIA 4 Series - SCANIA P/G/R/T Series - SCANIA BUS 4 Series

NR	GTSA KOD	DESCRIPTION	QTY
1	151.03	Caliper Pin - Ø36x114 mm	1
2	151.09	Caliper Pin - Ø32x84 mm	1
3	155.02.02	Caliper Pin Bolt - M16x1,50x85 mm	1
4	155.01.01	Caliper Pin Bolt - M16x1,50x80 mm	1
5	161.01	Caliper Pin Bush - Ø40xØ36x82 mm	1
6	165.19	Caliper Pin Rubber Bush - Ø39 mm	1
7	165.05	Caliper Pin Boot	1
8	165.08	Caliper Pin Boot Ring	1
9	165.16	Caliper Pin Boot	1
10	165.17	Caliper Pin Boot Ring	1
11	171.02	Caliper Pin Cap - Ø54x28 mm	1
12	191.02	Caliper Pin Cap Oring	1
13	165.18	Caliper Pin Cap - Ø40x36,50 mm	1
14	171.04	Caliper Pin Cap - Ø40x14,50 mm	1

KNR

SB6..SB7

GTK1.960 Caliper Pin Repair Kit

OEM NO: K001915 - K048389K50 - K099604K50

VEHICLE: MAN TGA

NR	GTSA KOD	DESCRIPTION	QTY
1	151.03	Caliper Pin - Ø36x114 mm	1
2	151.01	Caliper Pin - Ø32x80 mm	1
3	155.02.02	Caliper Pin Bolt - M16x1,50x85 mm	1
4	155.01.01	Caliper Pin Bolt - M16x1,50x80 mm	1
5	161.01	Caliper Pin Bush - Ø40xØ36x82 mm	1
6	165.10	Caliper Pin Rubber Bush - Ø39 mm (Short)	1
7	165.05	Caliper Pin Boot	1
8	165.08	Caliper Pin Boot Ring	1
9	171.04	Caliper Pin Cap - Ø40x14,50 mm	1

GTK1.964 Caliper Long Pin Repair Kit

OEM NO: K000696 - I1310370066

VEHICLE: MAN TGM - MAN TGA/TGS/TGX - MAN F2000 - MAN BUS - DAF LF 55 - DAF 75/85 CF - DAF CF 65/II/IV - DAF CF 75/IV - DAF CF 85/IV - DAF XF 95/105 - SCHMITZ TRAILER - BPW Axle - SAF Axle

NR	GTSA KOD	DESCRIPTION	QTY
1	151.03	Caliper Pin - Ø36x114 mm	1
2	155.02.02	Caliper Pin Bolt - M16x1,50x85 mm	1
3	161.01	Caliper Pin Bush - Ø40xØ36x82 mm	1
4	165.05	Caliper Pin Boot	1
5	165.08	Caliper Pin Boot Ring	1
6	171.02	Caliper Pin Cap - Ø54x28 mm	1
7	191.02	Caliper Pin Cap Oring	1

GTK1.971 Caliper Pin Repair Kit

OEM NO: K000687

VEHICLE: DAF 75/85 CF - DAF CF 65 - DAF CF 75/IV - DAF CF 85/IV - DAF XF 95/105

NR	GTSA KOD	DESCRIPTION	QTY
1	151.05	Caliper Pin - Ø36x145 mm	1
2	151.01	Caliper Pin - Ø32x80 mm	1
3	155.04	Caliper Pin Bolt - M16x1,50x150 mm	1
4	155.01.01	Caliper Pin Bolt - M16x1,50x80 mm	1
5	161.01	Caliper Pin Bush - Ø40xØ36x82 mm	1
6	165.05	Caliper Pin Boot	1
7	165.08	Caliper Pin Boot Ring	1
8	165.10	Caliper Pin Rubber Bush - Ø39 mm (Short)	1
9	165.06	Caliper Pin Bellow Cap	1
10	191.01	Caliper Pin Bellow Cap Clamp	1

GTK1.969 Caliper Pin Repair Kit



OEM NO: K000375

VEHICLE: MAN TGA/M2000 - IVECO EUROARGO - IVECO EUROTRAKKER - IVECO EUROSTAR - IVECO EUROTECH - IVECO STRALIS - SCANIA 4 Series - MB BUS CITARO - TRAVEGO - EVOBUS 33 - NEOPLAN - BOVA BUS - DENNIS TRIDENT - SCANIA BUS 114 - BPW Axle 19.5" - GIGANT Axle 19.5"/22.5" - LECINENA Axle 19.5"/22.5" - SMB Axle 22.5"

NR	GTSA KOD	DESCRIPTION	QTY
1	151.03	Caliper Pin - Ø36x114 mm	1
2	151.01	Caliper Pin - Ø32x80 mm	1
3	155.02.02	Caliper Pin Bolt - M16x1,50x85 mm	1
4	155.01.01	Caliper Pin Bolt - M16x1,50x80 mm	1
5	161.01	Caliper Pin Bush - Ø40xØ36x82 mm	1
6	165.11	Caliper Pin Rubber Bush - Ø39 mm	1
7	175.01	Caliper Pin Bolt Ring - Ø26x11,50 mm	1
8	165.05	Caliper Pin Boot	1
9	165.08	Caliper Pin Boot Ring	1
10	171.02	Caliper Pin Cap - Ø54x28 mm	1
11	191.02	Caliper Pin Cap Oring	1

GTK1.967 Caliper Pin Repair Kit



OEM NO: K001532

VEHICLE: MAN TGA - IVECO EUROARGO - IVECO EUROTRAKKER - IVECO EUROSTAR - IVECO EUROTECH - IVECO STRALIS - SCANIA 4 Series - BPW Axle - SAF Axle

NR	GTSA KOD	DESCRIPTION	QTY
1	151.03	Caliper Pin - Ø36x114 mm	1
2	151.01	Caliper Pin - Ø32x80 mm	1
3	155.02.02	Caliper Pin Bolt - M16x1,50x85 mm	1
4	155.01.01	Caliper Pin Bolt - M16x1,50x80 mm	1
5	161.01	Caliper Pin Bush - Ø40xØ36x82 mm	1
6	165.12	Caliper Pin Rubber Bush - Ø35 mm	1
7	175.01	Caliper Pin Bolt Ring - Ø26x11,50 mm	1
8	165.05	Caliper Pin Boot	1
9	165.08	Caliper Pin Boot Ring	1
10	171.02	Caliper Pin Cap - Ø54x28 mm	1
11	191.02	Caliper Pin Cap Oring	1

GTK1.975 Caliper Short Pin Repair Kit



OEM NO: B 09.801.06.90.0

VEHICLE:

NR	GTSA KOD	DESCRIPTION	QTY
1	151.01	Caliper Pin - Ø32x80 mm	1
2	155.01.01	Caliper Pin Bolt - M16x1,50x80 mm	1
3	165.12	Caliper Pin Rubber Bush - Ø35 mm	1
4	175.01	Caliper Pin Bolt Ring - Ø26x11,50 mm	1

KNR

SB6..SB7

GTK1.960-1

Caliper Pin Repair Kit



OEM NO

K048371K50

VEHICLE

MAN TGA - IVECO EUROARGO - IVECO EUROTRAKKER - IVECO EUROSTAR - IVECO EUROTCH - IVECO STRALIS - BPW Axle - SAF Axle

NR	GTSA KOD	DESCRIPTION	QTY
1	151.03	Caliper Pin - Ø36x114 mm	1
2	151.01	Caliper Pin - Ø32x80 mm	1
3	155.02.02	Caliper Pin Bolt - M16x1,50x85 mm	1
4	155.01.01	Caliper Pin Bolt - M16x1,50x80 mm	1
5	161.01	Caliper Pin Bush - Ø40xØ36x82 mm	1
6	165.10	Caliper Pin Rubber Bush - Ø39 mm (Short)	1
7	165.05	Caliper Pin Boot	1
8	165.08	Caliper Pin Boot Ring	1
9	171.02	Caliper Pin Cap - Ø54x28 mm	1
10	191.02	Caliper Pin Cap Oring	1

GTK1.963

Caliper Pin Repair Kit



OEM NO

II39769F0062

VEHICLE

MAN TGA / M2000 - DAF CF 65/75/85/LF55/XF95 - IVECO EUROARGO/EUROTRAKKER/EUROSTAR/EUROTCH/STRALIS - MB BUS CITARO/CITO/TRAVEGO 99 - EVO-BUS S3/S316/S328 - SCANIA BUS IRIZAR - SMB Axle 19.5"/22.5" - BPW Axle 19.5" - SAF Axle 22.5" - MB Axle 22.5" - MAN BUS - NEOPLAN - BOVA BUS - RABA BUS

NR	GTSA KOD	DESCRIPTION	QTY
1	151.03	Caliper Pin - Ø36x114 mm	1
2	151.02	Caliper Pin - Ø34x80 mm	1
3	155.02.02	Caliper Pin Bolt - M16x1,50x85 mm	2
4	161.01	Caliper Pin Bush - Ø40xØ36x82 mm	1
5	165.07	Caliper Pin Rubber Bush - Ø40xØ34x50 mm	1
6	165.05	Caliper Pin Boot	1
7	165.08	Caliper Pin Boot Ring	1
8	171.02	Caliper Pin Cap - Ø54x28 mm	1
9	191.02	Caliper Pin Cap Oring	1

GTK1.9008

Caliper Pin Repair Kit



OEM NO

II179320062

VEHICLE

MB BUS BM 671 - MB BUS BM 613/628/629/632 - MB BUS 633/634/671 - DAF OPTARE - BOVA BUS

NR	GTSA KOD	DESCRIPTION	QTY
1	151.04	Caliper Pin - Ø36x135 mm	1
2	151.07	Caliper Pin - Ø34x120 mm	1
3	155.03	Caliper Pin Bolt - M16x1,50x140 mm	1
4	155.06	Caliper Pin Bolt - M16x1,50x125 mm	1
5	161.01	Caliper Pin Bush - Ø40xØ36x82 mm	1
6	165.09	Caliper Pin Rubber Bush - Ø40xØ34x95 mm	1
7	165.26	Caliper Pin Boot	1
8	165.27	Caliper Pin Bellow Cap	1
9	191.01	Caliper Pin Bellow Cap Clamp	1

GTK1.9044 Caliper Pin Repair Kit

1- $\text{\O}36 \times 135 \text{ mm}$
2- $\text{\O}34 \times 80 \text{ mm}$
3- $\text{M}16 \times 1,50 \times 140 \text{ mm}$
4- $\text{M}16 \times 1,50 \times 85 \text{ mm}$
5- $\text{\O}40 \times \text{\O}36 \times 82 \text{ mm}$
6- $\text{\O}40 \times \text{\O}34 \times 50 \text{ mm}$
7- $\text{\O}40 \times 24,50 \text{ mm}$
8- $\text{\O}54 \times 28 \text{ mm}$
9- $\text{\O}40 \times 28 \text{ mm}$

OEM NO: II197330062

VEHICLE: MB ATEGO/ECONIC - SCANIA BUS 4 Series - SCANIA 4 Series

NR	GTSA KOD	DESCRIPTION	QTY
1	151.04	Caliper Pin - $\text{\O}36 \times 135 \text{ mm}$	1
2	151.02	Caliper Pin - $\text{\O}34 \times 80 \text{ mm}$	1
3	155.03	Caliper Pin Bolt - $\text{M}16 \times 1,50 \times 140 \text{ mm}$	1
4	155.02.02	Caliper Pin Bolt - $\text{M}16 \times 1,50 \times 85 \text{ mm}$	1
5	161.01	Caliper Pin Bush - $\text{\O}40 \times \text{\O}36 \times 82 \text{ mm}$	1
6	165.07	Caliper Pin Rubber Bush - $\text{\O}40 \times \text{\O}34 \times 50 \text{ mm}$	1
7	165.26	Caliper Pin Boot	1
8	165.27	Caliper Pin Bellow Cap	1
9	191.01	Caliper Pin Bellow Cap Clamp	1

GTK1.9028 Caliper Pin Repair Kit

1- $\text{\O}36 \times 114 \text{ mm}$
2- $\text{\O}36 \times 64 \text{ mm}$
3- $\text{M}16 \times 1,50 \times 85 \text{ mm}$
4- $\text{M}16 \times 1,50 \times 70 \text{ mm}$
5- $\text{\O}40 \times \text{\O}36 \times 82 \text{ mm}$
6- $\text{\O}40 \times \text{\O}36 \times 20 \text{ mm}$
7- $\text{\O}40 \times 24,50 \text{ mm}$
8- $\text{\O}54 \times 28 \text{ mm}$
9- $\text{\O}40 \times 28 \text{ mm}$
10- $\text{\O}40 \times 24,50 \text{ mm}$
11- $\text{\O}54 \times 28 \text{ mm}$

OEM NO: K010813

VEHICLE:

NR	GTSA KOD	DESCRIPTION	QTY
1	151.03	Caliper Pin - $\text{\O}36 \times 114 \text{ mm}$	1
2	151.06	Caliper Pin - $\text{\O}36 \times 64 \text{ mm}$	1
3	155.02.02	Caliper Pin Bolt - $\text{M}16 \times 1,50 \times 85 \text{ mm}$	1
4	155.05.01	Caliper Pin Bolt - $\text{M}16 \times 1,50 \times 70 \text{ mm}$	1
5	161.01	Caliper Pin Bush - $\text{\O}40 \times \text{\O}36 \times 82 \text{ mm}$	1
6	161.03	Caliper Pin Bush - $\text{\O}40 \times \text{\O}36 \times 20 \text{ mm}$	1
7	165.05	Caliper Pin Boot	2
8	165.08	Caliper Pin Boot Ring	2
9	171.03	Caliper Pin Cap - $\text{\O}40 \times 24,50 \text{ mm}$	1
10	171.02	Caliper Pin Cap - $\text{\O}54 \times 28 \text{ mm}$	1
11	191.02	Caliper Pin Cap Oring	1

GTK1.9051 Caliper Complete Mechanism Repair Kit

1- $\text{\O}74 \text{ mm}$
2- $\text{\O}74 \text{ mm}$
3- $\text{Angle: } 12^\circ - 122 \text{ mm}$
4- $\text{\O}74 \text{ mm}$
5- $\text{\O}74 \text{ mm}$
6- $\text{\O}74 \text{ mm}$
7- $\text{\O}74 \text{ mm}$
8- $\text{\O}74 \text{ mm}$

OEM NO:

VEHICLE:

NR	GTSA KOD	DESCRIPTION	QTY
1	GTK1.921	Caliper Tappet & Boot Set - $\text{\O}74 \text{ mm}$	1
2	GTK1.931	Caliper Shaft Housing Set	1
3	GTK1.941	Caliper Lever - (Angle: $12^\circ - 122 \text{ mm}$)	1
4	GTK1.945	Caliper Needle Bearing Set	1
5	GTK1.939	Caliper Calibration Shaft Chain (29 Links)	1
6	GTK1.936	Caliper Adjusting Mechanism Shaft	1
7	GTK1.937	Caliper Pinion Shaft	1
8	GTK1.907	Caliper Calibration Bolt	2

KNR

SB6..SB7

GTK1.981-4 Caliper Complete Mechanism Repair Kit



OEM NO

VEHICLE

NR	GTSA KOD	DESCRIPTION	QTY
1	GTK1.921	Caliper Tappet & Boot Set - Ø74mm	1
2	GTK1.931	Caliper Shaft Housing Set	1
3	GTK1.976	Caliper Lever - Straight (Angle:0°-127 mm)	1
4	GTK1.945	Caliper Needle Bearing Set	1
5	GTK1.939	Caliper Calibration Shaft Chain (29 Links)	1
6	GTK1.936	Caliper Adjusting Mechanism Shaft	1
7	GTK1.937	Caliper Pinion Shaft	1
8	GTK1.907	Caliper Calibration Bolt	2

GTK1.9052 Caliper Complete Mechanism Repair Kit



OEM NO

VEHICLE

NR	GTSA KOD	DESCRIPTION	QTY
1	GTK1.921	Caliper Tappet & Boot Set - Ø74mm	1
2	GTK1.931	Caliper Shaft Housing Set	1
3	GTK1.984	Caliper Lever - (Angle:12°-122 mm)	1
4	GTK1.945	Caliper Needle Bearing Set	1
5	GTK1.939	Caliper Calibration Shaft Chain (29 Links)	1
6	GTK1.936	Caliper Adjusting Mechanism Shaft	1
7	GTK1.937	Caliper Pinion Shaft	1
8	GTK1.907	Caliper Calibration Bolt	2

GTK1.916 Caliper Tappet & Boot Set



OEM NO

VEHICLE

NR	GTSA KOD	DESCRIPTION	QTY
1	168.06	Caliper Thrust Part With Bellow - Ø74 mm	2
2	161.02	Caliper Tappet Bush - Ø16xØ18x10 mm	2
3	165.05	Caliper Pin Boot	1
4	165.08	Caliper Pin Boot Ring	1
5	165.06	Caliper Pin Bellow Cap	1
6	191.01	Caliper Pin Bellow Cap Clamp	1
7	165.07	Caliper Pin Rubber Bush - Ø40xØ34x50 mm	1

GTK1.929 Caliper Short Pin Repair Kit



OEM NO: K000697

VEHICLE:

NR	GTSA KOD	DESCRIPTION	QTY
1	151.01	Caliper Pin - Ø32x80 mm	1
2	165.11	Caliper Pin Rubber Bush - Ø39 mm	1

GTK1.9059 Caliper Pin Repair Kit



OEM NO:

VEHICLE:

NR	GTSA KOD	DESCRIPTION	QTY
1	151.03	Caliper Pin - Ø36x114 mm	1
2	151.01	Caliper Pin - Ø32x80 mm	1
3	155.02.02	Caliper Pin Bolt - M16x1,50x85 mm	1
4	155.01.01	Caliper Pin Bolt - M16x1,50x80 mm	1
5	165.11	Caliper Pin Rubber Bush - Ø39 mm	1
6	175.01	Caliper Pin Bolt Ring - Ø26x11,50 mm	1

GTK1.9048 Caliper Pin Repair Kit



OEM NO: K048395K50

VEHICLE: MAN TGA - IVECO EURO CARGO - IVECO EURO TRAKKER - IVECO EUROSTAR - IVECO EUROTECH - IVECO STRALIS - BPW Axle - SAF Axle

NR	GTSA KOD	DESCRIPTION	QTY
1	151.03	Caliper Pin - Ø36x114 mm	1
2	151.01	Caliper Pin - Ø32x80 mm	1
3	155.02.02	Caliper Pin Bolt - M16x1,50x85 mm	1
4	155.01.01	Caliper Pin Bolt - M16x1,50x80 mm	1
5	161.01	Caliper Pin Bush - Ø40xØ36x82 mm	1
6	165.10-1	Caliper Pin Rubber Bush - Ø35 mm (Short)	1
7	165.05	Caliper Pin Boot	1
8	165.08	Caliper Pin Boot Ring	1
9	171.02	Caliper Pin Cap - Ø54x28 mm	1
10	191.02	Caliper Pin Cap O-ring	1

KNR

SB6..SB7

GTK1.9050 Caliper Complete Mechanism Repair Kit

OEM NO

VEHICLE

NR	GTSA KOD	DESCRIPTION	QTY
1	GTK1.921	Caliper Tappet & Boot Set - Ø74mm	1
2	GTK1.931	Caliper Shaft Housing Set	1
3	GTK1.942	Caliper Lever - Straight (Angle:0°-113 mm)	1
4	GTK1.945	Caliper Needle Bearing Set	1
5	GTK1.939	Caliper Calibration Shaft Chain (29 Links)	1
6	GTK1.936	Caliper Adjusting Mechanism Shaft	1
7	GTK1.937	Caliper Pinion Shaft	1
8	GTK1.907	Caliper Calibration Bolt	2

GTK1.950 Caliper Cap Set

OEM NO K001301

VEHICLE

NR	GTSA KOD	DESCRIPTION	QTY
1	171.02	Caliper Pin Cap - Ø54x28 mm	6
2	191.02	Caliper Pin Cap Oring	6
3	165.06	Caliper Pin Bellow Cap	6
4	191.01	Caliper Pin Bellow Cap Clamp	6

GTK1.987 Caliper Cap Set

OEM NO I1350470063

VEHICLE

NR	GTSA KOD	DESCRIPTION	QTY
1	165.06	Caliper Pin Bellow Cap	1
2	191.01	Caliper Pin Bellow Cap Clamp	1

GTK1.965 Caliper Short Pin Repair Kit



OEM NO: K000698

VEHICLE:

NR	GTSA KOD	DESCRIPTION	QTY
1	151.01	Caliper Pin - Ø32x80 mm	1
2	155.01.01	Caliper Pin Bolt - M16x1,50x80 mm	1
3	165.11	Caliper Pin Rubber Bush - Ø39 mm	1
4	175.01	Caliper Pin Bolt Ring - Ø26x11,50 mm	1

GTK1.921 Caliper Tappet & Boot Set - Ø74mm



OEM NO: K000944 - K010604 - K010606

VEHICLE: MB ACTROS/AXOR/ATEGO/ECONIC - MAN TGA/LM 2000 - DAF CF 65/75/85/LF55/XP95 - SCANIA 4 Series - SCANIA P/G/R/T Series - IVECO EUROTECH/EUROSTAR/EUROCARGO - MB BUS TRAVEGO - EVOBUS - MAN BUS - NEOPLAN - DAF BUS SB120 - BOVA BUS - DENNIS BUS - MB TRAILER Axle - BPW Axle - SAF Axle - SMB Axle - GIGANT Axle

NR	GTSA KOD	DESCRIPTION	QTY
1	168.06	Caliper Thrust Part With Bellow - Ø74 mm	2
2	165.03	Caliper Shaft Housing Boot - Ø74 mm	2
3	161.02	Caliper Tappet Bush - Ø16xØ18x10 mm	2

GTK1.924 Caliper Adjusting Mechanism Cap Set



OEM NO: K000945

VEHICLE:

NR	GTSA KOD	DESCRIPTION	QTY
1	165.13	Caliper Adjusting Mechanism Cap - Ø38 mm	10
2	165.15	Caliper Adjusting Mechanism Cap	10
3	191.03	Caliper Adjusting Mechanism Adapter	10

KNR

SB6..SB7

GTK1.921-1 Caliper Tappet Set	
OEM NO	1179320065 - 11304130065
VEHICLE	

NR	GTSA KOD	DESCRIPTION	QTY
1	168.06	Caliper Thrust Part With Bellow - Ø74 mm	2
2	161.02	Caliper Tappet Bush - Ø16xØ18x10 mm	2

GTK1.991 Caliper Cap Set	
OEM NO	1139769F0063

GTK1.947 Caliper Adjusting Mechanism Adapter Set	
OEM NO	Z001548
VEHICLE	

NR	GTSA KOD	DESCRIPTION	QTY
1	171.02	Caliper Pin Cap - Ø54x28 mm	1
2	191.02	Caliper Pin Cap Oring	1

GTK1.988 Caliper Shaft Housing Set	

GTK1.934 Caliper Shaft Housing Set	

NR	GTSA KOD	DESCRIPTION	QTY
1	GTK1.931	Caliper Shaft Housing Set	1
2	GTK1.938	Caliper Lever Bearing	1
3	GTK1.907	Caliper Calibration Bolt	2

NR	GTSA KOD	DESCRIPTION	QTY
1	GTK1.938	Caliper Lever Bearing	1
2	191.07	Caliper Shaft Housing Pin	1
3	191.09	Caliper Shaft Housing Pin Clamp	2

GTK1.928-1 Caliper Short Pin Repair Kit



NR	GTSA KOD	DESCRIPTION	QTY
1	151.01	Caliper Pin - Ø32x80 mm	1
2	155.01.01	Caliper Pin Bolt - M16x1,50x80 mm	1
3	165.10	Caliper Pin Rubber Bush - Ø39 mm (Short)	1

GTK1.927 Caliper Short Pin Repair Kit



NR	GTSA KOD	DESCRIPTION	QTY
1	151.07	Caliper Pin - Ø34x120 mm	1
2	165.09	Caliper Pin Rubber Bush - Ø40xØ34x95 mm	1

GTK1.928 Caliper Short Pin Repair Kit



NR	GTSA KOD	DESCRIPTION	QTY
1	151.01	Caliper Pin - Ø32x80 mm	1
2	165.10	Caliper Pin Rubber Bush - Ø39 mm (Short)	1

GTK1.930 Caliper Short Pin Repair Kit



NR	GTSA KOD	DESCRIPTION	QTY
1	151.01	Caliper Pin - Ø32x80 mm	1
2	165.12	Caliper Pin Rubber Bush - Ø35 mm	1

GTK1.986 Caliper Pin Boot Set



NR	GTSA KOD	DESCRIPTION	QTY
1	165.05	Caliper Pin Boot	1
2	165.08	Caliper Pin Boot Ring	1

GTK1.946 Caliper Needle Bearing Set



NR	GTSA KOD	DESCRIPTION	QTY
1	181.03	Caliper Needle Bearing	2

KNR

SB6..SB7

GTK1.905

Caliper Support Seal Set



NR	GTSA KOD	DESCRIPTION	QTY
1	165.29	Caliper Support Seal	5

GTK1.945

Caliper Needle Bearing Set



NR	GTSA KOD	DESCRIPTION	QTY
1	181.02	Caliper Needle Bearing	2

165.12

Caliper Pin Rubber Bush - Ø35 mm



OEM NO	
VEHICLE	

165.11

Caliper Pin Rubber Bush - Ø39 mm



OEM NO	
VEHICLE	

165.10

Caliper Pin Rubber Bush - Ø39 mm (Short)



OEM NO	
VEHICLE	

165.10-1

Caliper Pin Rubber Bush - Ø35 mm (Short)



OEM NO	
VEHICLE	

GTK1.9053 Caliper Plastic Cover (Without Sensor)	
	
OEM NO	
VEHICLE	TRAILER Axle

191.19 Caliper Plastic Cover Gasket	
	
OEM NO	
VEHICLE	

GTK1.919 Brake Pad Retainer Repair Kit	
	
OEM NO	K000129
VEHICLE	MB ACTROS/AXOR - SCANIA 4 Series - SCANIA P/G/R/T Series - BPW Axle - SAF Axle

GTK1.951 Brake Pad Retainer Repair Kit	
	
OEM NO	K0001133
VEHICLE	MB ATEGO 1/2/3

GTK1.9045 Brake Pad Retainer Repair Kit	
	
OEM NO	
VEHICLE	MB ATEGO 1/2/3

165.19 Caliper Pin Rubber Bush - Ø39 mm	
	
OEM NO	
VEHICLE	

KNR

SB6..SB7

GTK1.9000	Caliper Pinion Shaft
	
OEM NO	
VEHICLE	

GTK1.937-1	Caliper Pinion Shaft
	
OEM NO	
VEHICLE	

GTK1.9049	Caliper Pinion Shaft
	
OEM NO	
VEHICLE	

GTK1.9006	Caliper Pinion Shaft
	
OEM NO	
VEHICLE	

1.936-4	Caliper Mechanism Gear
	
OEM NO	
VEHICLE	

GTK1.939	Caliper Calibration Shaft Chain (29 Links)
 <p>29 Links</p>	
OEM NO	
VEHICLE	

All manufacturer names, trademarks, product descriptions contained in this product catalog are for reference only. All reference numbers are for comparison purposes.

GTK1.942 Caliper Lever - Straight (Angle:0°-113 mm)



OEM NO C73158

VEHICLE

GTK1.941 Caliper Lever - (Angle:12°-122 mm)



OEM NO C73164

VEHICLE

GTK1.976 Caliper Lever - Straight (Angle:0°-127 mm)



OEM NO

VEHICLE

GTK1.984 Caliper Lever - (Angle:12°-122 mm)



OEM NO

VEHICLE

GTK1.931 Caliper Shaft Housing Set



OEM NO

VEHICLE

GTK1.938 Caliper Lever Bearing



OEM NO

VEHICLE

KNR

SB6..SB7

GTK1.936 Caliper Adjusting Mechanism Shaft	
	
OEM NO	
VEHICLE	

GTK1.936-1 Caliper Adjusting Mechanism Shaft	
	
OEM NO	
VEHICLE	

GTK1.907 Caliper Calibration Bolt	
	
OEM NO	
VEHICLE	

GTK1.937 Caliper Pinion Shaft	
	
OEM NO	
VEHICLE	

GTK1.972-2 Caliper Plastic Cover (3 Wires Sensor)	
	
OEM NO	
VEHICLE	SCANIA 4 Series - IVECO STRALIS

GTK1.925 Brake Pad Retainer Repair Kit	
	
OEM NO	
VEHICLE	

GTK1.955

Caliper Plastic Cover (Without Sensor)



OEM NO

VEHICLE

MB ACTROS/AXOR/ATEGO - MAN TGA

GTK1.954

Caliper Plastic Cover (2 Wires Sensor)



OEM NO

VEHICLE

MB AXOR/ATEGO

GTK1.972

Caliper Plastic Cover (3 Wires Sensor)



OEM NO

VEHICLE

MB ACTROS

GTK1.972-1

Caliper Plastic Cover (3 Wires Sensor) - MAN



OEM NO

VEHICLE

MAN TGA

GTK1.9001

Caliper Plastic Cover (Without Sensor)



OEM NO

VEHICLE

SCANIA - DAF - IVECO

GTK1.9002

Caliper Plastic Cover (2 Wires Sensor)



OEM NO

VEHICLE

DAF

KNR

SB6..SB7

SK1003

Caliper Complete Repair Kit - Without Lever)



VEHICLE MAN TGA - New Model

NR	GTSA KOD	DESCRIPTION	QTY
1	GTK1.960	Caliper Pin Repair Kit	1
2	GTK1.921	Caliper Tappet & Boot Set - Ø74mm	1
3	GTK1.931	Caliper Shaft Housing Set	1
4	GTK1.945	Caliper Needle Bearing Set	1

NR	GTSA KOD	DESCRIPTION	QTY
5	GTK1.939	Caliper Calibration Shaft Chain (29 Links)	1
6	GTK1.936	Caliper Adjusting Mechanism Shaft	1
7	GTK1.937	Caliper Pinion Shaft	1
8	GTK1.907	Caliper Calibration Bolt	2

SK1005

Caliper Complete Repair Kit - Without Lever)



VEHICLE MB Axor - Old Model

NR	GTSA KOD	DESCRIPTION	QTY
1	GTK1.960	Caliper Pin Repair Kit	1
2	GTK1.921	Caliper Tappet & Boot Set - Ø74mm	1
3	GTK1.931	Caliper Shaft Housing Set	1
4	GTK1.946	Caliper Needle Bearing Set	1

NR	GTSA KOD	DESCRIPTION	QTY
5	GTK1.939	Caliper Calibration Shaft Chain (29 Links)	1
6	GTK1.936	Caliper Adjusting Mechanism Shaft	1
7	GTK1.937	Caliper Pinion Shaft	1
8	GTK1.907	Caliper Calibration Bolt	2

GTK1.957 Caliper Pin Repair Kit

1- $\varnothing 36 \times 145 \text{ mm}$
2- $\varnothing 34 \times 80 \text{ mm}$
3- 150 mm
4- 85 mm

OEM NO: II369100062 - II339680062

VEHICLE: MB BUS CITARO/CAPACITY - EVOBUS CITYBUS/C3 - MAN BUS LION'S CITY - NEOPLAN CENTROLINER - DAF BUS OPTARE - DENNIS BUS - VAN HOOL

NR	GTSA KOD	DESCRIPTION	QTY
1	151.05	Caliper Pin - $\varnothing 36 \times 145 \text{ mm}$	1
2	151.02	Caliper Pin - $\varnothing 34 \times 80 \text{ mm}$	1
3	155.04	Caliper Pin Bolt - M16x1,50x150 mm	1
4	155.02.02	Caliper Pin Bolt - M16x1,50x85 mm	1
5	161.01	Caliper Pin Bush - $\varnothing 40 \times \varnothing 36 \times 82 \text{ mm}$	1
6	165.07	Caliper Pin Rubber Bush - $\varnothing 40 \times \varnothing 34 \times 50 \text{ mm}$	1
7	165.05	Caliper Pin Boot	1
8	165.08	Caliper Pin Boot Ring	1
9	165.06	Caliper Pin Bellow Cap	1
10	191.01	Caliper Pin Bellow Cap Clamp	1

GTK1.970 Caliper Pin Repair Kit

1- $\varnothing 36 \times 145 \text{ mm}$
2- $\varnothing 34 \times 120 \text{ mm}$
3- 150 mm
4- 125 mm

OEM NO: II358510062

VEHICLE: SCANIA 4 Series - SCANIA BUS 3/4 Series - EVOBUS

NR	GTSA KOD	DESCRIPTION	QTY
1	151.05	Caliper Pin - $\varnothing 36 \times 145 \text{ mm}$	1
2	151.07	Caliper Pin - $\varnothing 34 \times 120 \text{ mm}$	1
3	155.04	Caliper Pin Bolt - M16x1,50x150 mm	1
4	155.06	Caliper Pin Bolt - M16x1,50x125 mm	1
5	161.01	Caliper Pin Bush - $\varnothing 40 \times \varnothing 36 \times 82 \text{ mm}$	1
6	165.09	Caliper Pin Rubber Bush - $\varnothing 40 \times \varnothing 34 \times 95 \text{ mm}$	1
7	165.05	Caliper Pin Boot	1
8	165.08	Caliper Pin Boot Ring	1
9	165.06	Caliper Pin Bellow Cap	1
10	191.01	Caliper Pin Bellow Cap Clamp	1

GTK1.987 Caliper Cap Set

OEM NO: II350470063

VEHICLE:

NR	GTSA KOD	DESCRIPTION	QTY
1	165.06	Caliper Pin Bellow Cap	1
2	191.01	Caliper Pin Bellow Cap Clamp	1

KNR

SB7..RADIAL

GTK1.927

Caliper Short Pin Repair Kit



NR	GTSA KOD	DESCRIPTION	QTY
1	151.07	Caliper Pin - Ø34x120 mm	1
2	165.09	Caliper Pin Rubber Bush - Ø40xØ34x95 mm	1

GTK1.9018

Caliper Lever - (Angle:93°mm)



OEM NO	
VEHICLE	MB BUS CITARO - MN BUS LIONS CITY A25/A26/A39 - SCN BUS 3/4 Series - NPLN CENTROLINER N4516/N4520 - VNHL A308/A309/AG330/AGG330 - DNNS BUS ENVIRO 400 TRIDENT 2/OPTARE/OLYMPUS/OMNIDEKKA - EVOBUS CITYBUS/A20/S3

GTK1.9010

Caliper Plastic Cover (Without Sensor)



OEM NO	
VEHICLE	MB BUS CITARO/CAPACITY - EVOBUS CITYBUS/S3

GTK1.9026

Caliper Plastic Cover (3 Wires Sensor)



OEM NO	
VEHICLE	MB BUS CITARO/CAPACITY - EVOBUS CITYBUS/S3

GTK1.9011

Caliper Plastic Cover (2 Wires Sensor)



OEM NO	
VEHICLE	MB BUS CITARO/CAPACITY - EVOBUS CITYBUS/S3

GTK1.9014

Caliper Plastic Cover (Without Sensor)



OEM NO	
VEHICLE	SCANIA BUS 3/4 Series

GTK1.9015 Caliper Plastic Cover (2 Wires Sensor)	
	
OEM NO	
VEHICLE	SCANIA BUS 3/4 Series

GTK1.9025 Caliper Plastic Cover (3 Wires Sensor)	
	
OEM NO	
VEHICLE	SCANIA BUS 3/4 Series

GTK1.980 Caliper Lever - (Angle:86°mm)	
	
OEM NO	K100259 - K000250
VEHICLE	

KNR

SN6..SN7..SK7

GTK1.9022 Caliper Pin Repair Kit

OEM NO: K067417K50

VEHICLE: MAN TGA - IVECO EUROARGO - IVECO EUROTRAKKER - IVECO EUROSTAR - IVECO EUROTCH - IVECO STRALIS - BPW Axle - SAF Axle

NR	GTSA KOD	DESCRIPTION	QTY
1	151.03	Caliper Pin - Ø36x114 mm	1
2	151.01	Caliper Pin - Ø32x80 mm	1
3	155.02.02	Caliper Pin Bolt - M16x1,50x85 mm	1
4	155.01.01	Caliper Pin Bolt - M16x1,50x80 mm	1
5	161.01	Caliper Pin Bush - Ø40xØ36x82 mm	1
6	165.11	Caliper Pin Rubber Bush - Ø39 mm	1
7	161.06	Rubber Bush Stop Ring - Ø35 mm	1
8	175.01	Caliper Pin Bolt Ring - Ø26x11,50 mm	1
9	165.05	Caliper Pin Boot	1
10	165.08	Caliper Pin Boot Ring	1
11	171.04	Caliper Pin Cap - Ø40x14,50 mm	1
12	171.02	Caliper Pin Cap - Ø54x28 mm	1
13	191.02	Caliper Pin Cap Oring	1

GTK1.962 Caliper Pin Repair Kit

OEM NO: K000472 - K017707

VEHICLE: MAN TGL/TGM/TGA/TGS/TGX/F2000 - DAF LF 55/ - DAF 75/85 CF - DAF CF 65/II/ IV - DAF CF 75/IV - DAF CF 85/IV - DAF XF 95/105 - MAN BUS - BPW Axle

NR	GTSA KOD	DESCRIPTION	QTY
1	151.03	Caliper Pin - Ø36x114 mm	1
2	151.01	Caliper Pin - Ø32x80 mm	1
3	155.02.02	Caliper Pin Bolt - M16x1,50x85 mm	1
4	155.01.01	Caliper Pin Bolt - M16x1,50x80 mm	1
5	161.01	Caliper Pin Bush - Ø40xØ36x82 mm	1
6	165.11	Caliper Pin Rubber Bush - Ø39 mm	1
7	175.01	Caliper Pin Bolt Ring - Ø26x11,50 mm	1
8	165.05	Caliper Pin Boot	1
9	165.08	Caliper Pin Boot Ring	1
10	171.04	Caliper Pin Cap - Ø40x14,50 mm	1

GTK1.9043 Caliper Pin Repair Kit

OEM NO: K052759K50

VEHICLE:

NR	GTSA KOD	DESCRIPTION	QTY
1	151.03	Caliper Pin - Ø36x114 mm	1
2	151.12	Caliper Pin - Ø32x88,50 mm	1
3	155.02.02	Caliper Pin Bolt - M16x1,50x85 mm	1
4	155.01.01	Caliper Pin Bolt - M16x1,50x80 mm	1
5	161.01	Caliper Pin Bush - Ø40xØ36x82 mm	1
6	165.11	Caliper Pin Rubber Bush - Ø39 mm	1
7	165.05	Caliper Pin Boot	1
8	165.08	Caliper Pin Boot Ring	1
9	171.04	Caliper Pin Cap - Ø40x14,50 mm	1

GTK1.9021 Caliper Pin Repair Kit

OEM NO

VEHICLE

NR	GTSA KOD	DESCRIPTION	QTY
1	151.03	Caliper Pin - Ø36x114 mm	1
2	151.01	Caliper Pin - Ø32x80 mm	1
3	151.02	Caliper Pin - Ø34x80 mm	1
4	155.02.02	Caliper Pin Bolt - M16x1,50x85 mm	2
5	155.01.01	Caliper Pin Bolt - M16x1,50x80 mm	1
6	161.01	Caliper Pin Bush - Ø40xØ36x82 mm	1
7	165.07	Caliper Pin Rubber Bush - Ø40xØ34x50 mm	1
8	165.10	Caliper Pin Rubber Bush - Ø39 mm (Short)	1
9	165.05	Caliper Pin Boot	1
10	165.08	Caliper Pin Boot Ring	1
11	171.04	Caliper Pin Cap - Ø40x14,50 mm	1
12	171.02	Caliper Pin Cap - Ø54x28 mm	1
13	191.02	Caliper Pin Cap Oring	1

GTK1.968-1 Caliper Pin Repair Kit

OEM NO

VEHICLE

NR	GTSA KOD	DESCRIPTION	QTY
1	151.08	Caliper Pin - Ø36x103 mm	1
2	151.01	Caliper Pin - Ø32x80 mm	1
3	155.02.02	Caliper Pin Bolt - M16x1,50x85 mm	1
4	155.01.01	Caliper Pin Bolt - M16x1,50x80 mm	1
5	161.09	Caliper Pin Bush - Ø40xØ36x75 mm	1
6	165.10	Caliper Pin Rubber Bush - Ø39 mm (Short)	1
7	165.05	Caliper Pin Boot	1
8	165.08	Caliper Pin Boot Ring	1
9	171.01	Caliper Pin Cap - Ø40x11 mm	1

GTK1.960 Caliper Pin Repair Kit

OEM NO

VEHICLE

NR	GTSA KOD	DESCRIPTION	QTY
1	151.03	Caliper Pin - Ø36x114 mm	1
2	151.01	Caliper Pin - Ø32x80 mm	1
3	155.02.02	Caliper Pin Bolt - M16x1,50x85 mm	1
4	155.01.01	Caliper Pin Bolt - M16x1,50x80 mm	1
5	161.01	Caliper Pin Bush - Ø40xØ36x82 mm	1
6	165.10	Caliper Pin Rubber Bush - Ø39 mm (Short)	1
7	165.05	Caliper Pin Boot	1
8	165.08	Caliper Pin Boot Ring	1
9	171.04	Caliper Pin Cap - Ø40x14,50 mm	1

KNR

SN6..SN7..SK7

GTK1.968 Caliper Pin Repair Kit



OEM NO: K001274 - K002716

VEHICLE: MB ATEGO 1/2/3 - DANA Axle - SMB Axle

NR	GTSA KOD	DESCRIPTION	QTY
1	151.08	Caliper Pin - Ø36x103 mm	1
2	151.01	Caliper Pin - Ø32x80 mm	1
3	155.02.02	Caliper Pin Bolt - M16x1,50x85 mm	1
4	155.01.01	Caliper Pin Bolt - M16x1,50x80 mm	1
5	161.09	Caliper Pin Bush - Ø40xØ36x75 mm	1
6	165.11	Caliper Pin Rubber Bush - Ø39 mm	1
7	175.01	Caliper Pin Bolt Ring - Ø26x11,50 mm	1
8	165.05	Caliper Pin Boot	1
9	165.08	Caliper Pin Boot Ring	1
10	171.01	Caliper Pin Cap - Ø40x11 mm	1

GTK1.966 Caliper Pin Repair Kit



OEM NO: K004100 - K004168 - K010766

VEHICLE: SAF SK RLB INTEGRAL - SAF SK NLB INTEGRAL - SAF SKRB INTEGRAL - SAF SKRS/SKRZ INTEGRAL

NR	GTSA KOD	DESCRIPTION	QTY
1	151.03	Caliper Pin - Ø36x114 mm	1
2	151.06	Caliper Pin - Ø36x64 mm	1
3	155.02.02	Caliper Pin Bolt - M16x1,50x85 mm	1
4	155.05.01	Caliper Pin Bolt - M16x1,50x70 mm	1
5	161.01	Caliper Pin Bush - Ø40xØ36x82 mm	1
6	161.03	Caliper Pin Bush - Ø40xØ36x20 mm	1
7	165.05	Caliper Pin Boot	2
8	165.08	Caliper Pin Boot Ring	2
9	171.03	Caliper Pin Cap - Ø40x24,50 mm	1
10	171.04	Caliper Pin Cap - Ø40x14,50 mm	1

GTK1.973 Caliper Pin Repair Kit



OEM NO: K031844K50 - K011117

VEHICLE: SCANIA 4 Series - SCANIA P/G/R/T Series - SCANIA BUS 4 Series

NR	GTSA KOD	DESCRIPTION	QTY
1	151.03	Caliper Pin - Ø36x114 mm	1
2	151.09	Caliper Pin - Ø32x84 mm	1
3	155.02.02	Caliper Pin Bolt - M16x1,50x85 mm	1
4	155.01.01	Caliper Pin Bolt - M16x1,50x80 mm	1
5	161.01	Caliper Pin Bush - Ø40xØ36x82 mm	1
6	165.19	Caliper Pin Rubber Bush - Ø39 mm	1
7	165.05	Caliper Pin Boot	1
8	165.08	Caliper Pin Boot Ring	1
9	165.16	Caliper Pin Boot	1
10	165.17	Caliper Pin Boot Ring	1
11	171.02	Caliper Pin Cap - Ø54x28 mm	1
12	191.02	Caliper Pin Cap Oring	1
13	165.18	Caliper Pin Cap - Ø40x36,50 mm	1
14	171.04	Caliper Pin Cap - Ø40x14,50 mm	1

GTK1.917 Caliper Pin & Boot Set - Ø69mm

OEM NO

VEHICLE

NR	GTSA KOD	DESCRIPTION	QTY
1	168.04	Caliper Thrust Part With Bellow - Ø69 mm	2
2	161.02	Caliper Tappet Bush - Ø18xØ16x10 mm	2
3	165.05	Caliper Pin Boot	1
4	165.08	Caliper Pin Boot Ring	1
5	165.06	Caliper Pin Bellow Cap	1
6	191.01	Caliper Pin Bellow Cap Clamp	1
7	165.07	Caliper Pin Rubber Bush - Ø40xØ34x50 mm	1

GTK1.966-1 Caliper Short Pin Repair Kit

OEM NO

VEHICLE

NR	GTSA KOD	DESCRIPTION	QTY
1	151.06	Caliper Pin - Ø36x64 mm	1
2	155.05.01	Caliper Pin Bolt - M16x1,50x70 mm	1
3	161.03	Caliper Pin Bush - Ø40xØ36x20 mm	1
4	165.05	Caliper Pin Boot	1
5	165.08	Caliper Pin Boot Ring	1
6	171.03	Caliper Pin Cap - Ø40x24,50 mm	1

GTK1.918 Caliper Tappet & Boot Set - Ø69mm

OEM NO

VEHICLE

NR	GTSA KOD	DESCRIPTION	QTY
1	168.04	Caliper Thrust Part With Bellow - Ø69 mm	2
2	165.01	Caliper Shaft Housing Boot - Ø69 mm	2
3	161.02	Caliper Tappet Bush - Ø18xØ16x10 mm	2

K001300 - K010603 - K000366 - K092079

MB ACTROS/AXOR/ATEGO 1/2/3 - MB ECONIC 1 - DAF 75/85 CF - DAF LF 55 - DAF CF 65/II - DAF CF 75/IV - DAF CF 85/IV - DAF XF 95/105 - MAN TGM/TGA/TGS/TGX - MAN BUS - SCANIA BUS 4 - SCANIA 4 Series - BPW Axle - SAF Axle - SCHMITZ Trailer

KNR

SN6..SN7..SK7

GTK1.948

Caliper Adjusting Mechanism Cap Set



OEM NO

K000029

NR	GTSA KOD	DESCRIPTION	QTY
1	165.13	Caliper Adjusting Mechanism Cap - Ø38 mm	10
2	191.03	Caliper Adjusting Mechanism Adapter	10

GTK1.949

Caliper Adjusting Mechanism Cap Set



OEM NO

K003902

NR	GTSA KOD	DESCRIPTION	QTY
1	165.14	Caliper Adjusting Mechanism Cap - Ø35 mm	10
2	191.03	Caliper Adjusting Mechanism Adapter	10

GTK1.901

Caliper Tappet & Boot Set - Ø69mm



NR	GTSA KOD	DESCRIPTION	QTY
1	168.04	Caliper Thrust Part With Bellow - Ø69 mm	1
2	165.01	Caliper Shaft Housing Boot - Ø69 mm	1
3	161.02	Caliper Tappet Bush - Ø18xØ16x10 mm	1

GTK1.990

Caliper Shaft Housing Set



NR	GTSA KOD	DESCRIPTION	QTY
1	GTK1.932	Caliper Shaft Housing Set	1
2	GTK1.938	Caliper Lever Bearing	1
3	GTK1.907	Caliper Calibration Bolt	2

GTK1.918-1

Caliper Tappet Set - Ø69mm



NR	GTSA KOD	DESCRIPTION	QTY
1	168.04	Caliper Thrust Part With Bellow - Ø69 mm	1
2	161.02	Caliper Tappet Bush - Ø18xØ16x10 mm	1

GTK1.989

Caliper Shaft Housing Set



NR	GTSA KOD	DESCRIPTION	QTY
1	GTK1.933	Caliper Shaft Housing Set	1
2	GTK1.907	Caliper Calibration Bolt	2



NR	GTSA KOD	DESCRIPTION	QTY
1	171.01	Caliper Pin Cap - Ø40x11 mm	1



NR	GTSA KOD	DESCRIPTION	QTY
1	171.04	Caliper Cap - Ø40x14,50 mm	5



NR	GTSA KOD	DESCRIPTION	QTY
1	171.03	Caliper Pin Cap - Ø40x24,50 mm	1



NR	GTSA KOD	DESCRIPTION	QTY
1	165.35	Caliper Sensor Plastic Locker	5



NR	GTSA KOD	DESCRIPTION	QTY
1	181.02	Caliper Needle Bearing	2



NR	GTSA KOD	DESCRIPTION	QTY
1	181.03	Caliper Needle Bearing	2

KNR

SN6..SN7..SK7

GTK1.914

Caliper Head Sealing Plug Set



NR	GTSA KOD	DESCRIPTION	QTY
1	165.30	Caliper Head Sealing Plug	5

GTK1.9035

Caliper Actuator Seal Set



NR	GTSA KOD	DESCRIPTION	QTY
1	165.31	Caliper Actuator Seal - Ø42,00 mm	5

GTK1.9056

Caliper Actuator Seal Set



NR	GTSA KOD	DESCRIPTION	QTY
1	165.32	Caliper Actuator Seal - Ø45,00 mm	5

165.19

Caliper Pin Rubber Bush - Ø39 mm



OEM NO	
VEHICLE	

GTK1.9006

Caliper Pinion Shaft



OEM NO	
VEHICLE	

1.936-4

Caliper Mechanism Gear



OEM NO	
VEHICLE	

GTK1.939 Caliper Calibration Shaft Chain (29 Links)



OEM NO	
VEHICLE	

GTK1.937-1 Caliper Pinion Shaft



OEM NO	
VEHICLE	

GTK1.933 Caliper Shaft Housing Set



OEM NO	
VEHICLE	

GTK1.932 Caliper Shaft Housing Set



OEM NO	
VEHICLE	

GTK1.940 Caliper Lever - Straight (Angle:0°-113 mm)



OEM NO	Z002881
VEHICLE	

GTK1.9003 Caliper Lever - Straight (Angle:0°-113 mm)



OEM NO	Z002881
VEHICLE	

KNR

SN6..SN7..SK7

GTK1.907 Caliper Calibration Bolt



OEM NO	
VEHICLE	

165.36 Caliper Actuator Seal - Ø57 mm



OEM NO	
VEHICLE	

GTK1.925 Brake Pad Retainer Repair Kit



OEM NO	
VEHICLE	

GTK1.919 Brake Pad Retainer Repair Kit



OEM NO	K000129
VEHICLE	MB ACTROS/AXOR - SCANIA 4 Series - SCANIA P/G/R/T Series - BPW Axle - SAF Axle

GTK1.953 Caliper Cover Set



OEM NO	
VEHICLE	

GTK1.974 Caliper Cover Set



OEM NO	
VEHICLE	

GTK1.9000 Caliper Pinion Shaft

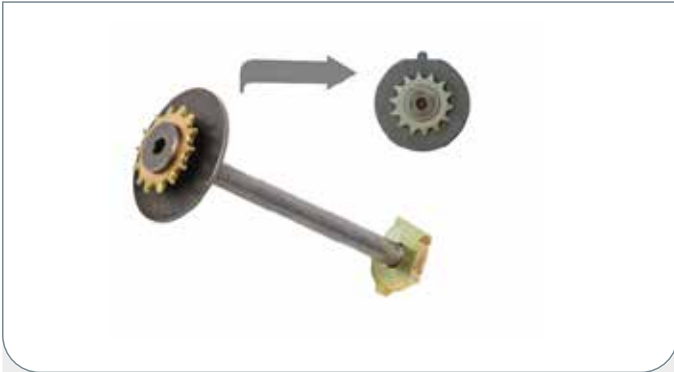

OEM NO

VEHICLE

GTK1.936-1 Caliper Adjusting Mechanism Shaft



OEM NO

VEHICLE

GTK1.936 Caliper Adjusting Mechanism Shaft



OEM NO

VEHICLE

GTK1.937 Caliper Pinion Shaft



OEM NO

VEHICLE

191.19 Caliper Plastic Cover Gasket

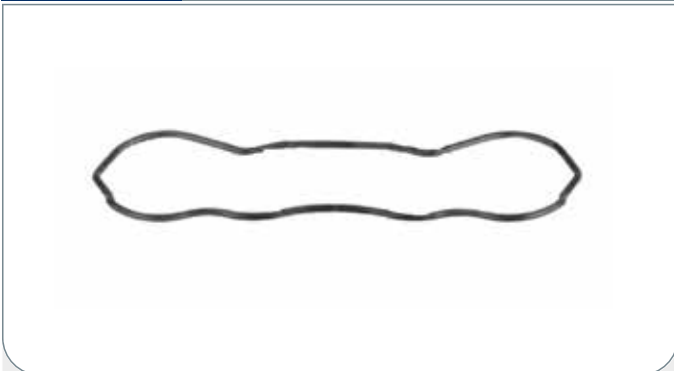

OEM NO

VEHICLE

GTK1.951 Brake Pad Retainer Repair Kit



OEM NO

K0001133

VEHICLE

MB ATEGO 1/2/3

KNR

SN6..SN7..SK7

GTK1.943 Caliper Lever - Straight (Angle:0°-124 mm)



OEM NO	Z002965
VEHICLE	

GTK1.9016 Caliper Lever - Straight (Angle:0°-124 mm)



OEM NO	Z002965
VEHICLE	

GTK1.977 Caliper Lever - (Angle:12°-122 mm)



OEM NO	Z002962
VEHICLE	

GTK1.944 Caliper Lever - (Angle:12°-122 mm)



OEM NO	Z002962
VEHICLE	

GTK1.972-2 Caliper Plastic Cover (3 Wires Sensor)



OEM NO	
VEHICLE	SCANIA 4 Series - IVECO STRALIS

GTK1.9053 Caliper Plastic Cover (Without Sensor)



OEM NO	
VEHICLE	TRAILER Axle

GTK1.955

Caliper Plastic Cover (Without Sensor)



OEM NO

VEHICLE

MB ACTROS/AXOR/ATEGO - MAN TGA

GTK1.954

Caliper Plastic Cover (2 Wires Sensor)



OEM NO

VEHICLE

MB AXOR/ATEGO

GTK1.972

Caliper Plastic Cover (3 Wires Sensor)



OEM NO

VEHICLE

MB ACTROS

GTK1.972-1

Caliper Plastic Cover (3 Wires Sensor) - MAN

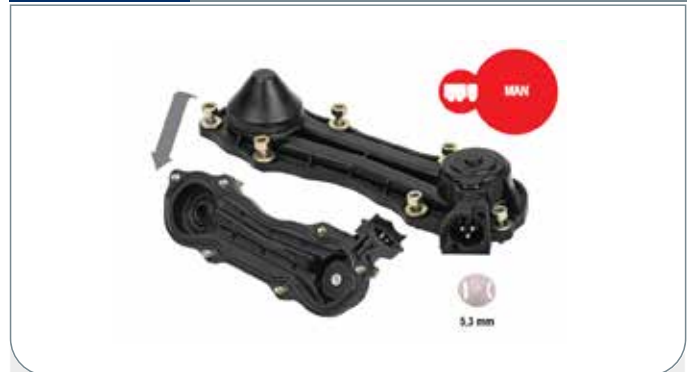

OEM NO

VEHICLE

MAN TGA

GTK1.9001

Caliper Plastic Cover (Without Sensor)



OEM NO

VEHICLE

SCANIA - DAF - IVECO

GTK1.9002

Caliper Plastic Cover (2 Wires Sensor)



OEM NO

VEHICLE

DAF

KNR

SN6..SN7..SK7

SK1006

Caliper Complete Repair Kit - (Without Lever) (New Model)



VEHICLE MB ACTROS (New Model) - BPW (New Model)

NR	GTSA KOD	DESCRIPTION	QTY	NR	GTSA KOD	DESCRIPTION	QTY
1	GTK1.962	Caliper Pin Repair Kit	1	5	GTK1.939	Caliper Calibration Shaft Chain (29 Links)	1
2	GTK1.918	Caliper Tappet & Boot Set - Ø69mm	1	6	GTK1.936	Caliper Adjusting Mechanism Shaft	1
3	GTK1.932	Caliper Shaft Housing Set	1	7	GTK1.937	Caliper Pinion Shaft	1
4	GTK1.946	Caliper Needle Bearing Set	1	8	GTK1.907	Caliper Calibration Bolt	2

SK1008

Caliper Complete Repair Kit - (Without Lever)(New Model)



VEHICLE MB AXOR (New Model)

NR	GTSA KOD	DESCRIPTION	QTY	NR	GTSA KOD	DESCRIPTION	QTY
1	GTK1.960	Caliper Pin Repair Kit	1	5	GTK1.939	Caliper Calibration Shaft Chain (29 Links)	1
2	GTK1.921	Caliper Tappet & Boot Set - Ø74mm	1	6	GTK1.936	Caliper Adjusting Mechanism Shaft	1
3	GTK1.932	Caliper Shaft Housing Set	1	7	GTK1.937	Caliper Pinion Shaft	1
4	GTK1.946	Caliper Needle Bearing Set	1	8	GTK1.907	Caliper Calibration Bolt	2

SK1007

Caliper Complete Repair Kit - Without Lever)



VEHICLE MB ACTROS (Old Model) - BPW (Old Model)

NR	GTSA KOD	DESCRIPTION	QTY
1	GTK1.967	Caliper Pin Repair Kit	1
2	GTK1.918	Caliper Tappet & Boot Set - $\varnothing 69$ mm	1
3	GTK1.933	Caliper Shaft Housing Set	1
4	GTK1.945	Caliper Needle Bearing Set	1
5	GTK1.939	Caliper Calibration Shaft Chain (29 Links)	1

NR	GTSA KOD	DESCRIPTION	QTY
6	GTK1.936	Caliper Adjusting Mechanism Shaft	1
7	GTK1.937	Caliper Pinion Shaft	1
8	GTK1.907	Caliper Calibration Bolt	2
9	GTK1.953	Caliper Cover Set	1

SK1004

Caliper Complete Repair Kit - Without Lever)



VEHICLE SCANIA 4 Series

NR	GTSA KOD	DESCRIPTION	QTY
1	GTK1.966	Caliper Pin Repair Kit	1
2	GTK1.918	Caliper Tappet & Boot Set - $\varnothing 69$ mm	1
3	GTK1.933	Caliper Shaft Housing Set	1
4	GTK1.945	Caliper Needle Bearing Set	1
5	GTK1.939	Caliper Calibration Shaft Chain (29 Links)	1

NR	GTSA KOD	DESCRIPTION	QTY
6	GTK1.936	Caliper Adjusting Mechanism Shaft	1
7	GTK1.937	Caliper Pinion Shaft	1
8	GTK1.907	Caliper Calibration Bolt	2
9	GTK1.953	Caliper Cover Set	1

KNR

SL7..SM7..ST7

GTK1.960

Caliper Pin Repair Kit



OEM NO

K001915 - K048389K50 - K099604K50

VEHICLE

MB ACTROS MPII/MPIV

NR	GTSA KOD	DESCRIPTION	QTY
1	151.03	Caliper Pin - Ø36x114 mm	1
2	151.01	Caliper Pin - Ø32x80 mm	1
3	155.02.02	Caliper Pin Bolt - M16x1,50x85 mm	1
4	155.01.01	Caliper Pin Bolt - M16x1,50x80 mm	1
5	161.01	Caliper Pin Bush - Ø40xØ36x82 mm	1
6	165.10	Caliper Pin Rubber Bush - Ø39 mm (Short)	1
7	165.05	Caliper Pin Boot	1
8	165.08	Caliper Pin Boot Ring	1
9	171.04	Caliper Pin Cap - Ø40x14,50 mm	1

GTK1.9054

Caliper Pin Repair Kit



OEM NO

K108002K50

VEHICLE

SCHIMITZ Trailer

NR	GTSA KOD	DESCRIPTION	QTY
1	151.03	Caliper Pin - Ø36x114 mm	1
2	151.06	Caliper Pin - Ø36x64 mm	1
3	155.02.02	Caliper Pin Bolt - M16x1,50x85 mm	1
4	155.05.01	Caliper Pin Bolt - M16x1,50x70 mm	1
5	161.01	Caliper Pin Bush - Ø40xØ36x82 mm	1
6	161.10	Caliper Pin Bush - Ø40xØ36x20 mm	1
7	165.05	Caliper Pin Boot	2
8	165.08	Caliper Pin Boot Ring	2
9	171.03	Caliper Pin Cap - Ø40x24,50 mm	1
10	171.04	Caliper Pin Cap - Ø40x14,50 mm	1

GTK1.9005

Caliper Tappet & Boot Set - Ø69mm

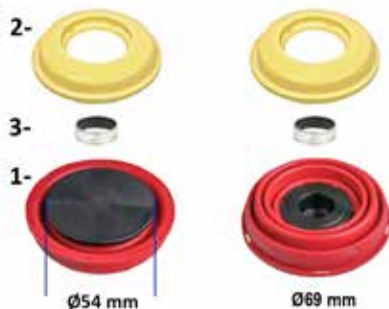

OEM NO

K046523K50 - K108004K50 - MB 000 423 0316

VEHICLE

MB ACTROS/AXOR - MPIII/MPIV - SCHIMITZ Trailer

NR	GTSA KOD	DESCRIPTION	QTY
1	168.08	Caliper Thrust Part With Bellow - Ø54 mm	2
2	165.01	Caliper Shaft Housing Boot - Ø69 mm	2
3	161.05	Caliper Tappet Bush - Ø17xØ15x8 mm	2

GTK1.948 Caliper Adjusting Mechanism Cap Set



OEM NO	K000029
--------	---------

NR	GTSA KOD	DESCRIPTION	QTY
1	165.13	Caliper Adjusting Mechanism Cap - Ø38 mm	10
2	191.03	Caliper Adjusting Mechanism Adapter	10

GTK1.926 Caliper Needle Bearing Set



OEM NO	
VEHICLE	MB ACTROS/AXOR - MPIII/MPIV - SCHMITZ Trailer

NR	GTSA KOD	DESCRIPTION	QTY
1	181.04	Caliper Needle Bearing	2

GTK1.9058 Caliper Shaft Housing Set



NR	GTSA KOD	DESCRIPTION	QTY
1	GTK1.933	Caliper Shaft Housing Set	1
2	GTK1.9007	Caliper Calibration Bolt	2

GTK1.914 Caliper Head Sealing Plug Set



NR	GTSA KOD	DESCRIPTION	QTY
1	165.30	Caliper Head Sealing Plug	5

GTK1.9020-1 Caliper Cap Set



NR	GTSA KOD	DESCRIPTION	QTY
1	171.04	Caliper Cap - Ø40x14,50 mm	5

GTK1.9023 Caliper Cap Set



NR	GTSA KOD	DESCRIPTION	QTY
1	171.03	Caliper Pin Cap - Ø40x24,50 mm	1

KNR

SL7..SM7..ST7

191.19	Caliper Plastic Cover Gasket
	
OEM NO	
VEHICLE	

GTK1.9007	Caliper Calibration Bolt
	
OEM NO	
VEHICLE	

GTK1.9057	Caliper Calibration Bolt (New Model)
	
OEM NO	
VEHICLE	

GTK1.9006	Caliper Pinion Shaft
	
OEM NO	
VEHICLE	

GTK1.937	Caliper Pinion Shaft
	
OEM NO	
VEHICLE	

GTK1.9000	Caliper Pinion Shaft
	
OEM NO	
VEHICLE	

GTK1.937-1 Caliper Pinion Shaft



OEM NO	
VEHICLE	

1.936-4 Caliper Mechanism Gear



OEM NO	
VEHICLE	

GTK1.939 Caliper Calibration Shaft Chain (29 Links)

29 Links



OEM NO	
VEHICLE	

GTK1.933 Caliper Shaft Housing Set



OEM NO	
VEHICLE	

GTK1.936 Caliper Adjusting Mechanism Shaft



OEM NO	
VEHICLE	

GTK1.936-1 Caliper Adjusting Mechanism Shaft



OEM NO	
VEHICLE	

KNR

SL7..SM7..ST7

GTK1.9004 Caliper Lever - Straight (Angle:12°-122 mm)



OEM NO Z033222

VEHICLE

GTK1.9034 Caliper Lever - Straight (Angle:12°-122 mm)



OEM NO

VEHICLE SCHMITZ Trailer

GTK1.944 Caliper Lever - (Angle:12°-122 mm)



OEM NO Z002962

VEHICLE

GTK1.936-2 Caliper Adjusting Mechanism Shaft (New Model)



OEM NO

VEHICLE

GTK1.953 Caliper Cover Set



OEM NO

VEHICLE

GTK1.974 Caliper Cover Set



OEM NO

VEHICLE

GTK1.951 Brake Pad Retainer Repair Kit



25 mm

OEM NO	K0001133 - MB 000 420 2582
VEHICLE	MB ATEGO 1/2/3

GTK1.972-1 Caliper Plastic Cover (3 Wires Sensor) - MAN



MAN

5.3 mm

OEM NO	
VEHICLE	MAN TGA

GTK1.9053 Caliper Plastic Cover (Without Sensor)



OEM NO	
VEHICLE	TRAILER Axle

GTK1.955 Caliper Plastic Cover (Without Sensor)



OEM NO	
VEHICLE	MB ACTROS/AXOR/ATEGO - MAN TGA

GTK1.954 Caliper Plastic Cover (2 Wires Sensor)



5.3 mm

OEM NO	
VEHICLE	MB AXOR/ATEGO

GTK1.972 Caliper Plastic Cover (3 Wires Sensor)



5.3 mm

OEM NO	
VEHICLE	MB ACTROS

KNR

SL7..SM7..ST7

SK1009

Caliper Complete Repair Kit - Without Lever)

VEHICLE MB ACTROS /AXOR - MPIII/IV - Rear

NR	GTSA KOD	DESCRIPTION	QTY
1	GTK1.960	Caliper Pin Repair Kit	1
2	GTK1.9005	Caliper Tappet & Boot Set - Ø69mm	1
3	GTK1.933	Caliper Shaft Housing Set	1
4	GTK1.926	Caliper Needle Bearing Set	1
5	GTK1.939	Caliper Calibration Shaft Chain (29 Links)	1

NR	GTSA KOD	DESCRIPTION	QTY
6	GTK1.936	Caliper Adjusting Mechanism Shaft	1
7	GTK1.9006	Caliper Pinion Shaft	1
8	GTK1.9007	Caliper Calibration Bolt	2
9	GTK1.974	Caliper Cover Set	1



MRT

GTM2.866 Caliper Pin Repair Kit



OEM NO: MCK1140 - MCK1243

VEHICLE: MAN TGA/TGS/TGX/TGL - MAN L/M/F 2000 - RENAULT PREMIUM/PF - RENAULT MAGNUM E-TECH - RENAULT MIDLUM / PUNCHER - MAN BUS LION'S CITY - NEOPLAN CENTROLINER - VOLVO BUS B7L

NR	GTSA KOD	DESCRIPTION	QTY
1	251.04	Caliper Pin - Ø35x144 mm	1
2	251.03	Caliper Pin - Ø31x84 mm	1
3	255.06	Caliper Pin Bolt - M18x1,50x150 mm	1
4	255.05	Caliper Pin Bolt - M18x1,50x90 mm	1
5	261.11	Caliper Pin Oval Bush - Ø42xØ33/31x30 mm	1
6	261.02	Caliper Pin Bush - Ø39xØ35x30 mm	2
7	275.05	Caliper Pin Boot Ring - Ø42xØ37x14 mm	2
8	271.02	Caliper Pin Cap - Ø44x28 mm	2
9	255.13	Brake Pad Retainer Bolt - M10x1,25x20 mm	1
10	255.07	Caliper Bridge Bolt - M16x1,50x40 mm	4
11	265.03	Caliper Pin Boot	2

GTM2.873-1 Caliper Boot & Pin Repair Kit



OEM NO:

VEHICLE:

NR	GTSA KOD	DESCRIPTION	QTY
1	251.04	Caliper Pin - Ø35x144 mm	1
2	251.03	Caliper Pin - Ø31x84 mm	1
3	255.06	Caliper Pin Bolt - M18x1,50x150 mm	1
4	255.05	Caliper Pin Bolt - M18x1,50x90 mm	1
5	261.05	Caliper Pin Rubber Bush - Ø42xØ32/31x45 mm	1
6	261.02	Caliper Pin Bush - Ø39xØ35x30 mm	2
7	275.05	Caliper Pin Boot Ring - Ø42xØ37x14 mm	1
8	271.02	Caliper Pin Cap - Ø44x28 mm	2
9	255.07	Caliper Bridge Bolt - M16x1,50x40 mm	4
10	265.03	Caliper Pin Boot	2
11	265.20	Caliper Tappet Boot	2

GTM2.873-2 Caliper Pin Repair Kit



OEM NO: MCK1289 - MN 81.50802.6026

VEHICLE:

NR	GTSA KOD	DESCRIPTION	QTY
1	251.04	Caliper Pin - Ø35x144 mm	1
2	251.03	Caliper Pin - Ø31x84 mm	1
3	255.06	Caliper Pin Bolt - M18x1,50x150 mm	1
4	255.05	Caliper Pin Bolt - M18x1,50x90 mm	1
5	261.05	Caliper Pin Rubber Bush - Ø42xØ32/31x45 mm	1
6	261.02	Caliper Pin Bush - Ø39xØ35x30 mm	2
7	275.05	Caliper Pin Boot Ring - Ø42xØ37x14 mm	1
8	271.02	Caliper Pin Cap - Ø44x28 mm	2
9	255.07	Caliper Bridge Bolt - M16x1,50x40 mm	4
10	265.03	Caliper Pin Boot	2

MRT

ELSA 2

GTM2.858 Caliper Boot & Pin Repair Kit



OEM NO

VEHICLE

NR	GTSA KOD	DESCRIPTION	QTY
1	251.04	Caliper Pin - Ø35x144 mm	1
2	251.03	Caliper Pin - Ø31x84 mm	1
3	261.05	Caliper Pin Rubber Bush - Ø42xØ32/31x45 mm	1
4	261.02	Caliper Pin Bush - Ø39xØ35x30 mm	2
5	275.05	Caliper Pin Boot Ring - Ø42xØ37x14 mm	1
6	271.02	Caliper Pin Cap - Ø44x28 mm	2
7	265.20	Caliper Tappet Boot	2
8	265.03	Caliper Pin Boot	2

GTM2.859 Caliper Pin Repair Kit



OEM NO MCK1086 - MN ZG002950002 - DF 1522185 - RNL 5001 858 717

VEHICLE RENAULT PREMIUM /TR/PR - RENAULT MAGNUM E-TECH

NR	GTSA KOD	DESCRIPTION	QTY
1	251.12	Caliper Pin - Ø35x128 mm	1
2	251.11	Caliper Oval Pin - Ø35/33x66 mm	1
3	255.01	Caliper Pin Bolt - M20x1,50x150 mm	1
4	255.02	Caliper Pin Bolt - M20x1,50x90 mm	1
5	261.02	Caliper Pin Bush - Ø39xØ35x30 mm	3
6	275.06	Caliper Pin Boot Ring - Ø43xØ35x2,50 mm	2
7	271.02	Caliper Pin Cap - Ø44x28 mm	2
8	255.13	Brake Pad Retainer Bolt - M10x1,25x20 mm	1
9	255.07	Caliper Bridge Bolt - M16x1,50x40 mm	4
10	265.03	Caliper Pin Boot	2

GTM2.875 Caliper Boot & Bolt Set



OEM NO MCK1244 -RNL 5001 858 718 - 5001 860 792

VEHICLE

NR	GTSA KOD	DESCRIPTION	QTY
1	255.07	Caliper Bridge Bolt - M16x1,50x40 mm	4
2	271.02	Caliper Pin Cap - Ø44x28 mm	2
3	265.11	Caliper Rubber Cap	1
4	265.35	Caliper Actuator Seal (With Pin)	1
5	265.20	Caliper Tappet Boot	2
6	265.03	Caliper Pin Boot	2

GTM2.874 Caliper Adjusting Mechanism Cap (With Bush)



OEM NO

VEHICLE

NR	GTSA KOD	DESCRIPTION	QTY
1	2.874	Caliper Aluminum Cap	1
2	GTM2.8025	Caliper Gear Bush & Seal Set	1
3	255.27	Caliper Aluminum Cap Bolt - M10x1,25x45 mm	8
4	GTM2.876	Caliper Aluminum Cap Gasket	1

GTM2.8038 Caliper Adjusting Mechanism Cap



OEM NO 68323564

VEHICLE

NR	GTSA KOD	DESCRIPTION	QTY
1	2.8038	Caliper Aluminum Cap	1
2	291.43	Caliper Gear Seal	2
3	255.27	Caliper Aluminum Cap Bolt - M10x1,25x45 mm	8
4	GTM2.876-1	Caliper Aluminum Cap Gasket	1

GTM2.8094 Caliper Adjusting Mechanism Set



OEM NO

VEHICLE

NR	GTSA KOD	DESCRIPTION	QTY
1	GTM2.835	Caliper Adjusting Mechanism Cap	1
2	GTM2.833	Caliper Adjusting Mechanism	1
3	GTM2.834	Caliper Adjusting Mechanism Gear Set	1
4	GTM2.8051	Caliper Tappet Boot Set	1

MRT

ELSA 2

GTM2.840-1 Caliper Bearing Set



OEM NO SJ4098 - VLV 3092261

VEHICLE

NR	GTSA KOD	DESCRIPTION	QTY
1	GTM2.839	Caliper Needle Bearing Set	1
2	281.03	Caliper Lever Roller Bearing	2
3	281.06	Caliper Lever Bearing	2

GTM2.8036-1 Caliper Lever



OEM NO

VEHICLE

NR	GTSA KOD	DESCRIPTION	QTY
1	GTM2.8036	Caliper Lever	1
2	281.03	Caliper Lever Roller Bearing	2
3	265.10	Caliper Actuator Seal	1
4	GTM2.839	Caliper Needle Bearing Set	1

GTM2.8095 Caliper Adjusting Mechanism Set



OEM NO

VEHICLE

NR	GTSA KOD	DESCRIPTION	QTY
1	GTM2.8038	Caliper Adjusting Mechanism Cap	1
2	GTM2.8039	Caliper Adjusting Mechanism	1
3	GTM2.8040	Caliper Adjusting Mechanism Gear Set	1
4	GTM2.8051	Caliper Tappet Boot Set	1

GTM2.835 Caliper Adjusting Mechanism Cap



OEM NO: 68324625

VEHICLE:

NR	GTSA KOD	DESCRIPTION	QTY
1	2.835	Caliper Aluminum Cap	1
2	GTM2.8025	Caliper Gear Bush & Seal Set	1
3	255.27	Caliper Aluminum Cap Bolt - M10x1,25x45 mm	8
4	GTM2.876	Caliper Aluminum Cap Gasket	1

GTM2.840 Caliper Bearing Set



OEM NO: DF 1522169 - SJ4112 - VLV 3092329

VEHICLE: VOLVO FH12/FH16 - VOLVO FM9/FM12/FMX - VOLVO BUS B7/B12

NR	GTSA KOD	DESCRIPTION	QTY
1	GTM2.839	Caliper Needle Bearing Set	1
2	281.03	Caliper Lever Roller Bearing	2
3	281.02	Caliper Lever Bearing	2

GTM2.8028 Caliper Tappet Boot



OEM NO: MCK1309 - VLV 85109891 - RNLT 5001 866 398

VEHICLE: VOLVO FH12/FH16 - VOLVO FM9/FM12 - ROR Axle

NR	GTSA KOD	DESCRIPTION	QTY
1	265.20	Caliper Tappet Boot	2
2	268.02	Caliper Tappet	2
3	261.14	Caliper Tappet Ring - Ø34xØ32x6,50 mm	2

MRT

ELSA 2

GTM2.8051

Caliper Tappet Boot Set



OEM NO	MCK1139
VEHICLE	MAN TGA/TGS/TGX/TGL - MAN L/M/F 2000 - MAN BUS LION'S CITY - NEOPLAN CENTROLINER - VOLVO FH12/FH16 - VOLVO FM9/FM12 - VOLVO BUS

NR	GTSA KOD	DESCRIPTION	QTY
1	265.20	Caliper Tappet Boot	2

GTM2.839

Caliper Needle Bearing Set



OEM NO	DF 1522169 - SJ4112 - VLV 3092329
VEHICLE	VOLVO FH12/FH16 - VOLVO FM9/FM12/FM2 - VOLVO BUS B7/B12

NR	GTSA KOD	DESCRIPTION	QTY
1	281.01	Caliper Needle Bearing	2

GTM2.8028-1

Caliper Tappet Boot



NR	GTSA KOD	DESCRIPTION	QTY
1	268.02	Caliper Tappet	2
2	261.14	Caliper Tappet Ring - Ø34xØ32x6,50 mm	2

GTM2.8036-2

Caliper Lever



NR	GTSA KOD	DESCRIPTION	QTY
1	GTM2.8036	Caliper Lever	1
2	281.03	Caliper Lever Roller Bearing	2

GTM2.834

Caliper Adjusting Mechanism Gear Set



NR	GTSA KOD	DESCRIPTION	QTY
1	2.834	Caliper Adjusting Mechanism Gear - Ø49,50 mm	2

GTM2.838-1

Caliper Lever - (123 mm)



NR	GTSA KOD	DESCRIPTION	QTY
1	GTM2.838	Caliper Lever	1
2	281.03	Caliper Lever Roller Bearing	2

GTM2.849 Caliper Pin Boot Set



NR	GTSA KOD	DESCRIPTION	QTY
1	265.03	Caliper Pin Boot	2

GTM2.8025 Caliper Gear Bush & Seal Set



NR	GTSA KOD	DESCRIPTION	QTY
1	291.42	Caliper Tappet Boot Ring	2
2	291.41	Caliper Adjusting Mechanism Gear Bush	2
3	291.43	Caliper Gear Mechanism Seal	2

GTM2.8118 Caliper Visual Indicator

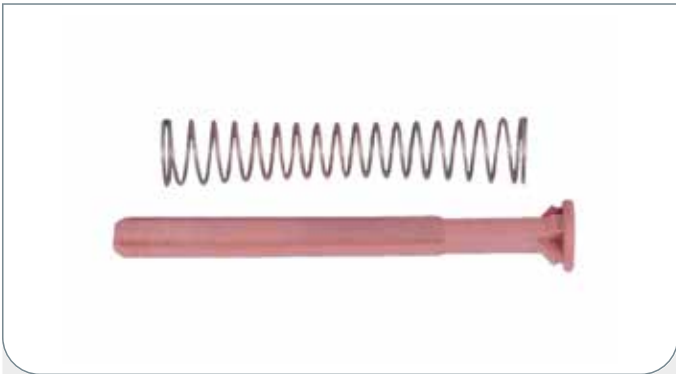

OEM NO	
VEHICLE	

GTM2.8041 Brake Pad Retainer Repair Kit



OEM NO	MCK1174 - MN 81.50822.0014 - 06.01771.8107 - 35.50307.5700
VEHICLE	MAN TGA/TGS/TGX/TGL - MAN L/M/F 2000 - MAN BUS LION'S CITY/ CLASSIC - NEOPLAN CENTROLINER

GTM2.838 Caliper Lever - (123 mm)



OEM NO	
VEHICLE	

281.06 Caliper Lever Bearing



OEM NO	
VEHICLE	

MRT
ELSA 2

GTM2.837

Caliper Manual Adjusting Gear - L



OEM NO

VEHICLE

GTM2.8035

Caliper Bearing Saddle Set



OEM NO

VEHICLE

GTM2.836

Caliper Manual Adjusting Gear - R



OEM NO

VEHICLE

281.02

Caliper Lever Bearing



OEM NO

VEHICLE

GTM2.8040

Caliper Adjusting Mechanism Gear Set



OEM NO

VEHICLE

GTM2.8036

Caliper Lever



OEM NO

VEHICLE

265.09

Caliper Actuator Seal (Without Pin)



OEM NO

VEHICLE

265.35

Caliper Actuator Seal (With Pin)



OEM NO

VEHICLE

GTM2.833

Caliper Adjusting Mechanism



OEM NO

VEHICLE

261.05

Caliper Pin Rubber Bush - Ø42xØ32/31x45 mm



OEM NO

VEHICLE

GTM2.876-1

Caliper Aluminum Cap Gasket



OEM NO

VEHICLE

GTM2.876

Caliper Aluminum Cap Gasket



OEM NO

VEHICLE

MRT

ELSA 2

SM2037

Caliper Complete Repair Kit - L



VEHICLE

RENAULT PREMIUM/MAGNUM - MAN TGA / F2000 - MAN L2000 / M2000 - RENAULT BUS ARES - MAN BUS LION'S CITY/ CLASSIC - NEOPLAN CENTROLINER - VAN HOOL BUS

NR	GTSA KOD	DESCRIPTION	QTY	NR	GTSA KOD	DESCRIPTION	QTY
1	GTM2.866	Caliper Pin Repair Kit	1	7	275.10	Caliper Mechanism Seal Ring	1
2	265.35	Caliper Actuator Seal (With Pin)	1	8	GTM2.839	Caliper Needle Bearing Set	1
3	GTM2.8094	Caliper Adjusting Mechanism Set	1	9	GTM2.838-1	Caliper Lever - (123 mm)	1
4	GTM2.837	Caliper Manual Adjusting Gear - L	1	10	GTM2.8035	Caliper Bearing Saddle Set	1
5	265.11	Caliper Rubber Cap	1	11	GTM2.8118	Caliper Visual Indicator	1
6	265.13	Caliper Manual Adjusting Shaft Seal	1	12	GTM2.8041	Brake Pad Retainer Repair Kit	1

SM2001

Caliper Complete Repair Kit - L (Without Lever)



VEHICLE

RENAULT 420 (Old Model)

NR	GTSA KOD	DESCRIPTION	QTY	NR	GTSA KOD	DESCRIPTION	QTY
1	GTM2.866	Caliper Pin Repair Kit	1	6	265.13	Caliper Manual Adjusting Shaft Seal	1
2	265.35	Caliper Actuator Seal (With Pin)	1	7	275.10	Caliper Mechanism Seal Ring	1
3	GTM2.8094	Caliper Adjusting Mechanism Set	1	8	GTM2.840	Caliper Bearing Set	1
4	GTM2.837	Caliper Manual Adjusting Gear - L	1	9	GTM2.8035	Caliper Bearing Saddle Set	1
5	265.11	Caliper Rubber Cap	1	10	GTM2.8118	Caliper Visual Indicator	1

SM2039

Caliper Complete Repair Kit - R



VEHICLE

RENAULT PREMIUM/MAGNUM - MAN TGA / F2000 - MAN L2000 / M2000 - RENAULT BUS ARES - MAN BUS LION'S CITY/
CLASSIC - NEOPLAN CENTROLINER - VAN HOOL BUS

NR	GTSA KOD	DESCRIPTION	QTY	NR	GTSA KOD	DESCRIPTION	QTY
1	GTM2.866	Caliper Pin Repair Kit	1	7	275.10	Caliper Mechanism Seal Ring	1
2	265.35	Caliper Actuator Seal (With Pin)	1	8	GTM2.839	Caliper Needle Bearing Set	1
3	GTM2.8094	Caliper Adjusting Mechanism Set	1	9	GTM2.838-1	Caliper Lever - (123 mm)	1
4	GTM2.836	Caliper Manual Adjusting Gear - R	1	10	GTM2.8035	Caliper Bearing Saddle Set	1
5	265.11	Caliper Rubber Cap	1	11	GTM2.8118	Caliper Visual Indicator	1
6	265.13	Caliper Manual Adjusting Shaft Seal	1	12	GTM2.8041	Brake Pad Retainer Repair Kit	1

SM2002

Caliper Complete Repair Kit - R (Without Lever)



VEHICLE

RENAULT 420 (Old Model)

NR	GTSA KOD	DESCRIPTION	QTY	NR	GTSA KOD	DESCRIPTION	QTY
1	GTM2.866	Caliper Pin Repair Kit	1	6	265.13	Caliper Manual Adjusting Shaft Seal	1
2	265.35	Caliper Actuator Seal (With Pin)	1	7	275.10	Caliper Mechanism Seal Ring	1
3	GTM2.8094	Caliper Adjusting Mechanism Set	1	8	GTM2.840	Caliper Bearing Set	1
4	GTM2.836	Caliper Manual Adjusting Gear - R	1	9	GTM2.8035	Caliper Bearing Saddle Set	1
5	265.11	Caliper Rubber Cap	1	10	GTM2.8118	Caliper Visual Indicator	1

MRT

ELSA 2

SM2003

Caliper Complete Repair Kit - L (Without Lever)



VEHICLE RENAULT 420 (New Model) - MAN TGA (New Model)

NR	GTSA KOD	DESCRIPTION	QTY	NR	GTSA KOD	DESCRIPTION	QTY
1	GTM2.859	Caliper Pin Repair Kit	1	6	265.13	Caliper Manual Adjusting Shaft Seal	1
2	265.35	Caliper Actuator Seal (With Pin)	1	7	275.10	Caliper Mechanism Seal Ring	1
3	GTM2.8095	Caliper Adjusting Mechanism Set	1	8	GTM2.840-1	Caliper Bearing Set	1
4	GTM2.837	Caliper Manual Adjusting Gear - L	1	9	GTM2.8035	Caliper Bearing Saddle Set	1
5	265.11	Caliper Rubber Cap	1	10	GTM2.8118	Caliper Visual Indicator	1

SM2004

Caliper Complete Repair Kit - R (Without Lever)



VEHICLE RENAULT 420 (New Model) - MAN TGA (New Model)

NR	GTSA KOD	DESCRIPTION	QTY	NR	GTSA KOD	DESCRIPTION	QTY
1	GTM2.859	Caliper Pin Repair Kit	1	6	265.13	Caliper Manual Adjusting Shaft Seal	1
2	265.35	Caliper Actuator Seal (With Pin)	1	7	275.10	Caliper Mechanism Seal Ring	1
3	GTM2.8095	Caliper Adjusting Mechanism Set	1	8	GTM2.840-1	Caliper Bearing Set	1
4	GTM2.836	Caliper Manual Adjusting Gear - R	1	9	GTM2.8035	Caliper Bearing Saddle Set	1
5	265.11	Caliper Rubber Cap	1	10	GTM2.8118	Caliper Visual Indicator	1

GTM2.879 Caliper Pin Repair Kit



OEM NO MCK1254 - MN STRMCK1254 - ZG070160007 - VLV AMMCK1254 - PCCR 871054

VEHICLE VOLVO FH / FM Rear (Radial Type) - ROR Axle LM / LMC / TA (Axial Type)

NR	GTSA KOD	DESCRIPTION	QTY
1	251.17	Caliper Pin - Ø35x117 mm	1
2	251.16	Caliper Pin - Ø31x78 mm	1
3	255.12	Caliper Pin Bolt - M18x1,50x120 mm	1
4	255.10	Caliper Pin Bolt - M18x1,50x80 mm	1
5	261.11	Caliper Pin Oval Bush - Ø42xØ33/31x30 mm	1
6	261.02	Caliper Pin Bush - Ø39xØ35x30 mm	2
7	275.07	Caliper Pin Boot Ring - Ø39xØ37x10 mm	2
8	271.03	Caliper Pin Cap - Ø44x17 mm	2
9	255.11.01	Caliper Bridge Bolt - M14x1,50x40 mm	4
10	265.03	Caliper Pin Boot	2

GTM2.878 Caliper Pin Repair Kit



OEM NO MCK1298 - VLV 85109890 - PCCR 9500931 - RVI 5001 866 989

VEHICLE VOLVO FH12 / FM12 Rear (19.5" Axle Type) - VOLVO FH12 / FM12 Rear (22.5" Axle Type) - VOLVO BUS B7R/B9R/B12R/B12M Rear (22.5" Axle Type)

NR	GTSA KOD	DESCRIPTION	QTY
1	251.20	Caliper Pin - Ø35x117 mm (Double Line)	1
2	251.19	Caliper Pin - Ø31x78 mm (Double Line)	1
3	255.12	Caliper Pin Bolt - M18x1,50x120 mm	1
4	255.10	Caliper Pin Bolt - M18x1,50x80 mm	1
5	261.11	Caliper Pin Oval Bush - Ø42xØ33/31x30 mm	1
6	261.02	Caliper Pin Bush - Ø39xØ35x30 mm	2
7	275.07	Caliper Pin Boot Ring - Ø39xØ37x10 mm	2
8	271.03	Caliper Pin Cap - Ø44x17 mm	2
9	255.11.01	Caliper Bridge Bolt - M14x1,50x40 mm	4
10	255.07.01	Caliper Bridge Bolt - M16x1,50x40 mm	4
11	265.03	Caliper Pin Boot	2

GTM2.8052 Caliper Pin Repair Kit



OEM NO MCK1317 - VLV 85109889

VEHICLE VOLVO FH12 / FM12 Rear (22.5" Radial Type) - VOLVO BUS B7R/B9R/B12R/B12M Rear (22.5" Radial Type) - RENAULT TRUCK Front (22.5" Radial Type)

NR	GTSA KOD	DESCRIPTION	QTY
1	251.20	Caliper Pin - Ø35x117 mm (Double Line)	1
2	251.26	Caliper Pin - Ø31x117 mm (Double Line)	1
3	255.12	Caliper Pin Bolt - M18x1,50x120 mm	2
4	261.11	Caliper Pin Oval Bush - Ø42xØ33/31x30 mm	2
5	275.07	Caliper Pin Boot Ring - Ø39xØ37x10 mm	2
6	261.02	Caliper Pin Bush - Ø39xØ35x30 mm	2
7	271.03	Caliper Pin Cap - Ø44x17 mm	2
8	255.07.01	Caliper Bridge Bolt - M16x1,50x40 mm	4
9	255.13	Caliper Bolt - M10x1,25x20 mm	1
10	265.03	Caliper Pin Boot	2

MRT

ELSA195 - ELSA225 - EX225

GTM2.8027

Caliper Adjusting Mechanism Cap



OEM NO

68325646

VEHICLE

NR	GTSA KOD	DESCRIPTION	QTY
1	2.8027	Caliper Aluminum Cap	1
2	GTM2.8025	Caliper Gear Bush & Seal Set	1
3	265.25	Caliper Aluminum Cap Gasket	1
4	255.27	Caliper Aluminum Cap Bolt - M8x1,25x45 mm	8

GTM2.8027-1

Caliper Adjusting Mechanism Cap (With Bush)



OEM NO

VEHICLE

NR	GTSA KOD	DESCRIPTION	QTY
1	2.8027-1	Caliper Aluminum Cap	1
2	GTM2.8025	Caliper Gear Bush & Seal Set	1
3	265.25	Caliper Aluminum Cap Gasket	1
4	255.27	Caliper Aluminum Cap Bolt - M8x1,25x45 mm	8

GTM2.880

Caliper Boot & Cap Set



OEM NO

MCK1253 - MN STRMCK1253 - DF 884368 - VLV AMMCK1253

VEHICLE

NR	GTSA KOD	DESCRIPTION	QTY
1	255.11.01	Caliper Bridge Bolt - M14x1,50x40 mm	4
2	271.03	Caliper Pin Cap - Ø44x17 mm	2
3	265.03	Caliper Pin Boot	2

GTM2.840 Caliper Bearing Set



OEM NO: DF 1522169 - SJ4112 - VLV 3092329

VEHICLE: VOLVO FH12/FH16 - VOLVO FM9/FM12/FMX - VOLVO BUS B7/B12

NR	GTSA KOD	DESCRIPTION	QTY
1	GTM2.839	Caliper Needle Bearing Set	1
2	281.03	Caliper Lever Roller Bearing	2
3	281.02	Caliper Lever Bearing	2

GTM2.8069 Caliper Adjusting Mechanism Set



OEM NO:

VEHICLE:

NR	GTSA KOD	DESCRIPTION	QTY
1	GTM2.8027	Caliper Adjusting Mechanism Cap	1
2	GTM2.833	Caliper Adjusting Mechanism	1
3	GTM2.834	Caliper Adjusting Mechanism Gear Set	1
4	GTM2.8051	Caliper Tappet Boot Set	1

GTM2.8028 Caliper Tappet & Boot Set



OEM NO: MCK1309 - VLV 85109891 - RNLT 5001 866 398

VEHICLE: VOLVO FH12/FH16 - VOLVO FM9/FM12 - ROR Axle

NR	GTSA KOD	DESCRIPTION	QTY
1	265.20	Caliper Tappet Boot	2
2	268.02	Caliper Tappet	2
3	261.14	Caliper Tappet Ring - Ø34xØ32x6,50 mm	2

MRT

ELSA195 - ELSA225 - EX225

GTM2.8051 Caliper Tappet Boot Set



OEM NO	MCK1139
VEHICLE	MAN TGA/TGS/TGX/TGL - MAN L/M/F 2000 - MAN BUS LION'S CITY - NEOPLAN CENTROLINER - VOLVO FH12/FH16 - VOLVO FM9/FM12 - VOLVO BUS

NR	GTSA KOD	DESCRIPTION	QTY
1	265.20	Caliper Tappet Boot	2

GTM2.839 Caliper Needle Bearing Set



OEM NO	DF 1522169 - SJ4112 - VLV 3092329
VEHICLE	VOLVO FH12/FH16 - VOLVO FM9/FM12/FM3 - VOLVO BUS B7/B12

NR	GTSA KOD	DESCRIPTION	QTY
1	281.01	Caliper Needle Bearing	2

GTM2.8028-1 Caliper Tappet Set



NR	GTSA KOD	DESCRIPTION	QTY
1	268.02	Caliper Tappet	2
2	261.14	Caliper Tappet Ring - Ø34xØ32x6,50 mm	2

GTM2.849 Caliper Pin Boot Set



NR	GTSA KOD	DESCRIPTION	QTY
1	265.03	Caliper Pin Boot	2

GTM2.8063 Caliper Lever



NR	GTSA KOD	DESCRIPTION	QTY
1	2.8063	Caliper Lever	1
2	281.02	Caliper Lever Bearing	2

GTM2.8029-1 Caliper Lever



NR	GTSA KOD	DESCRIPTION	QTY
1	GTM2.8029	Caliper Lever	1
2	281.03	Caliper Lever Roller Bearing	2

GTM2.8034-1 Caliper Lever



NR	GTSA KOD	DESCRIPTION	QTY
1	GTM2.8034	Caliper Lever	1
2	281.03	Caliper Lever Roller Bearing	2

GTM2.8025 Caliper Gear Bush & Seal Set



NR	GTSA KOD	DESCRIPTION	QTY
1	291.42	Caliper Tappet Boot Ring	2
2	291.41	Caliper Adjusting Mechanism Gear Bush	2
3	291.43	Caliper Gear Mechanism Seal	2

GTM2.834 Caliper Adjusting Mechanism Gear Set



NR	GTSA KOD	DESCRIPTION	QTY
1	2.834	Caliper Adjusting Mechanism Gear - Ø49,50	2

GTM2.8099 Caliper Manual Adjusting Gear



OEM NO	
VEHICLE	OLD Model

GTM2.8030 Caliper Manual Adjusting Gear



OEM NO	
VEHICLE	

265.25 Caliper Aluminum Cap Gasket



OEM NO	
VEHICLE	

MRT

ELSA195 - ELSA225 - EX225

265.09

Caliper Actuator Seal (Without Pin)



OEM NO

VEHICLE

281.02

Caliper Lever Bearing



OEM NO

VEHICLE

GTM2.8037

Caliper Visual Indicator



OEM NO

MCK1311

VEHICLE

GTM2.8035

Caliper Bearing Saddle Set



OEM NO

VEHICLE

GTM2.8041

Brake Pad Retainer Repair Kit



OEM NO

MCK1174 - MN 81.50822.0014 - 06.01771.8107

VEHICLE

MAN TGA/TGS/TGX/TGL - MAN L/M/F 2000 - MAN BUS LION'S CITY/
CLASSIC - NEOPLAN CENTROLINER

GTM2.833

Caliper Adjusting Mechanism



OEM NO

VEHICLE

SM2005

Caliper Complete Repair Kit - (Without Lever)



VEHICLE RENAULT PREMIUM 440

NR	GTSA KOD	DESCRIPTION	QTY	NR	GTSA KOD	DESCRIPTION	QTY
1	GTM2.879	Caliper Pin Repair Kit	1	6	265.13	Caliper Manual Adjusting Shaft Seal	1
2	265.35	Caliper Actuator Seal (With Pin)	1	7	275.10	Caliper Mechanism Seal Ring	1
3	GTM2.8069	Caliper Adjusting Mechanism Set	1	8	GTM2.840	Caliper Bearing Set	1
4	GTM2.8030	Caliper Manual Adjusting Gear	1	9	GTM2.8035	Caliper Bearing Saddle Set	1
5	265.11	Caliper Rubber Cap	1	10	GTM2.8037	Caliper Visual Indicator	1

SM2039

Caliper Complete Repair Kit - R



VEHICLE VOLVO FH12/FM12 Rear (22.5" Radial Type) - VOLVO BUS B7R/B12R/B12M Rear (22.5" Radial Type) - RENAULT TRUCK Front (22.5" Radial Type)

NR	GTSA KOD	DESCRIPTION	QTY	NR	GTSA KOD	DESCRIPTION	QTY
1	GTM2.8052	Caliper Pin Repair Kit	1	7	275.10	Caliper Mechanism Seal Ring	1
2	265.09	Caliper Actuator Seal	1	8	GTM2.839	Caliper Needle Bearing Set	1
3	GTM2.8069	Caliper Adjusting Mechanism Set	1	9	GTM2.8034-1	Caliper Lever	1
4	GTM2.8030	Caliper Manual Adjusting Gear	1	10	GTM2.8035	Caliper Bearing Saddle Set	1
5	265.11	Caliper Rubber Cap	1	11	GTM2.8037	Caliper Visual Indicator	1
6	265.13	Caliper Manual Adjusting Shaft Seal	1	12	GTM2.8041	Brake Pad Retainer Repair Kit	1

MRT ELSA 1

GTM2.852 Caliper Pin Repair Kit

OEM NO: MCK1102 - ST1157 - DF 1522034

VEHICLE: MAN TGA / F2000 - MAN BUS LION'S CITY/COACH / STAR - NEOP-LAN CENTROLINER / TOURLINER / TROLLEY

NR	GTSA KOD	DESCRIPTION	QTY
1	251.02	Caliper Pin - Ø35x135 mm	1
2	251.01	Caliper Pin - Ø35x73 mm	1
3	255.01	Caliper Pin Bolt - M20x1,50x150 mm	1
4	255.02	Caliper Pin Bolt - M20x1,50x90 mm	1
5	261.01	Caliper Pin Oval Bush - Ø40xØ37/35x33 mm	1
6	261.02	Caliper Pin Bush - Ø39xØ35x30 mm	2
7	275.01	Caliper Pin Boot Ring - Ø39xØ37/36x15 mm (With Step)	1
8	275.02	Caliper Pin Boot Ring - Ø40xØ37x15 mm (Without Step)	1
9	275.03	Caliper Pin Boot Ring - Ø48xØ37x14 mm	2
10	271.01	Caliper Pin Cap - Ø44x28 mm	2
11	265.04	Caliper Pin Boot	2

GTM2.852-1 Caliper Pin Repair Kit

OEM NO:

VEHICLE:

NR	GTSA KOD	DESCRIPTION	QTY
1	251.02	Caliper Pin - Ø35x135 mm	1
2	251.01	Caliper Pin - Ø35x73 mm	1
3	255.01	Caliper Pin Bolt - M20x1,50x150 mm	1
4	255.02	Caliper Pin Bolt - M20x1,50x90 mm	1
5	261.01	Caliper Pin Oval Bush - Ø40xØ37/35x33 mm	1
6	261.02	Caliper Pin Bush - Ø39xØ35x30 mm	2
7	275.01	Caliper Pin Boot Ring - Ø39xØ37/36x15 mm (With Step)	1
8	275.02	Caliper Pin Boot Ring - Ø40xØ37x15 mm (Without Step)	1
9	275.03	Caliper Pin Boot Ring - Ø48xØ37x14 mm	2
10	271.01	Caliper Pin Cap - Ø44x28 mm	2
11	265.04	Caliper Pin Boot	2
12	265.02	Caliper Tappet Boot	2

GTM2.853 Caliper Pin Repair Kit

OEM NO: MCK1103 - MN 81.50802.6022

VEHICLE: MAN BUS A13 / A32 - MAN BUS LION'S CLASSIC

NR	GTSA KOD	DESCRIPTION	QTY
1	251.18	Caliper Pin (With Bolt) - Ø28,50x110 mm	1
2	251.02	Caliper Pin - Ø35x135 mm	1
3	255.01	Caliper Pin Bolt - M20x1,50x150 mm	1
4	265.08	Caliper Pin Rubber Bush - Ø40xØ28,50x27 mm	1
5	261.02	Caliper Pin Bush - Ø39xØ35x30 mm	2
6	275.04	Caliper Pin Boot Ring - Ø40xØ30x19 mm	1
7	275.01	Caliper Pin Boot Ring - Ø39xØ37/36x15 mm (With Step)	1
8	271.01	Caliper Pin Cap - Ø44x28 mm	2
9	265.04	Caliper Pin Boot	2

GTM2.8070-1 Caliper Adjusting Gear Set - Ø35 mm - R



OEM NO	
VEHICLE	

NR	GTSA KOD	DESCRIPTION	QTY
1	GTM2.804	Mechanism Intermediate Gear - Ø35 mm	1
2	291.73	Caliper Adjusting Gear Spring - Ø49,50x57 mm	1
3	GTM2.800	Caliper Adjusting Gear - Ø35 mm- R	2
4	291.26	Caliper Gear Slot	2

GTM2.8071-1 Caliper Adjusting Gear Set - Ø35 mm - L



OEM NO	
VEHICLE	

NR	GTSA KOD	DESCRIPTION	QTY
1	GTM2.804	Mechanism Intermediate Gear - Ø35 mm	1
2	291.73	Caliper Adjusting Gear Spring - Ø49,50x57 mm	1
3	GTM2.801	Caliper Adjusting Gear - Ø35 mm- L	2
4	291.26	Caliper Gear Slot	2

GTM2.8071 Caliper Adjusting Gear Set - Ø37,50 mm - L



OEM NO	
VEHICLE	

NR	GTSA KOD	DESCRIPTION	QTY
1	GTM2.805	Mechanism Intermediate Gear - Ø37,50 mm	1
2	291.73	Caliper Adjusting Gear Spring - Ø49,50x57 mm	1
3	GTM2.803	Caliper Adjusting Gear - Ø37,50 mm- L	2
4	291.26	Caliper Gear Slot	2

MRT

ELSA 1

GTM2.810-1

Caliper Lever Return Spring Set - L



OEM NO

VEHICLE

NR	GTSA KOD	DESCRIPTION	QTY
1	291.61	Caliper Lever Return Spring - L	1
2	291.62	Caliper Lever Return Retainer	1
3	291.63	Caliper Lever Pin	1
4	291.64	Caliper Mechanism Adjuster Bracket	1
5	255.30	Bolt - M6x12 mm	2

GTM2.809-1

Caliper Lever Return Spring Set - R



OEM NO

VEHICLE

NR	GTSA KOD	DESCRIPTION	QTY
1	291.60	Caliper Lever Return Spring - R	1
2	291.62	Caliper Lever Return Retainer	1
3	291.63	Caliper Lever Pin	1
4	291.64	Caliper Mechanism Adjuster Bracket	1
5	255.30	Bolt - M6x12 mm	2

GTM2.840

Caliper Bearing Set



OEM NO

DF 1522169 - SJ4112 - VLV 3092329

VEHICLE

VOLVO FH12/FH16 - VOLVO FM9/FM12/FMX - VOLVO BUS B7/B12

NR	GTSA KOD	DESCRIPTION	QTY
1	GTM2.839	Caliper Needle Bearing Set	1
2	281.03	Caliper Lever Roller Bearing	2
3	281.02	Caliper Lever Bearing	2

GTM2.847 Caliper Tappet Boot Set



OEM NO ST1156 - RNLT 5001 849 886 - MN 81.50802.6016

VEHICLE

NR	GTSA KOD	DESCRIPTION	QTY
1	265.02	Caliper Tappet Boot	2

GTM2.8070 Caliper Adjusting Gear Set - Ø37,50 mm - R



OEM NO

VEHICLE

NR	GTSA KOD	DESCRIPTION	QTY
1	GTM2.805	Mechanism Intermediate Gear - Ø37,50 mm	1
2	291.73	Caliper Adjusting Gear Spring - Ø49,50x57 mm	1
3	GTM2.802	Caliper Adjusting Gear - Ø37,50 mm- R	2
4	291.26	Caliper Gear Slot	2

GTM2.840-1 Caliper Bearing Set



OEM NO SJ4098 - VLV 3092261

VEHICLE

NR	GTSA KOD	DESCRIPTION	QTY
1	GTM2.839	Caliper Needle Bearing Set	1
2	281.03	Caliper Lever Roller Bearing	2
3	281.06	Caliper Lever Bearing	2

MRT

ELSA 1

GTM2.839		Caliper Needle Bearing Set	
			
OEM NO	DF 1522169 - SJ4112 - VLV 3092329		
VEHICLE	VOLVO FH12/FH16 - VOLVO FM9/FM12/FMX - VOLVO BUS B7/B12		

NR	GTSA KOD	DESCRIPTION	QTY
1	281.01	Caliper Needle Bearing	2

GTM2.867		Caliper Gear Slot Set	
			
NR	GTSA KOD	DESCRIPTION	QTY
1	291.26	Caliper Gear Slot	2

GTM2.8101		Caliper Gear Bush Set - Ø37,50 mm	
			
NR	GTSA KOD	DESCRIPTION	QTY
1	261.18	Caliper Gear Bush - Ø37,50 mm	2

GTM2.854		Caliper Pin Boot Set	
			
NR	GTSA KOD	DESCRIPTION	QTY
1	265.04	Caliper Pin Boot	2

GTM2.8100		Caliper Gear Bush Set - Ø35 mm	
			
NR	GTSA KOD	DESCRIPTION	QTY
1	261.19	Caliper Gear Bush - Ø35 mm	2

GTM2.811

Caliper Adjusting Gear Locking Shim



OEM NO 68321678 - MN 81.50822.0006 - ZF 0501318076

VEHICLE

GTM2.801

Caliper Adjusting Gear - Ø 35 mm - L



OEM NO

VEHICLE

GTM2.808

Caliper Manual Adjusting Gear



OEM NO

VEHICLE

GTM2.803

Caliper Adjusting Gear - Ø 37,50 mm - L



OEM NO

VEHICLE

GTM2.807

Caliper Mechanism Adjuster - (44 mm) L



OEM NO

VEHICLE

GTM2.802

Caliper Adjusting Gear - Ø 37,50 mm - R



OEM NO

VEHICLE

MRT
ELSA 1

GTM2.806 Caliper Mechanism Adjuster - (44 mm) R



OEM NO	
VEHICLE	

GTM2.868 Caliper Cover Gasket

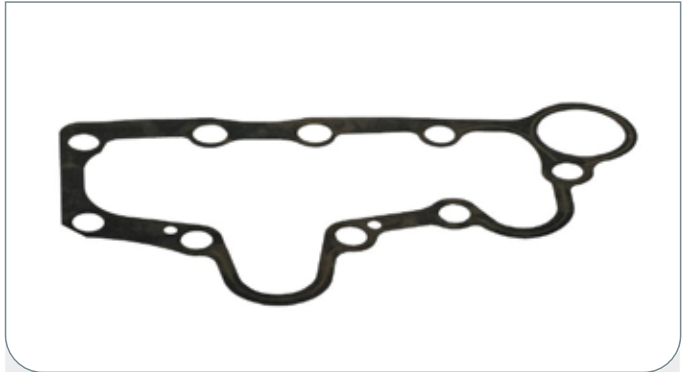

OEM NO	
VEHICLE	

GTM2.8044 Caliper Small Gear Mechanism - L



OEM NO	68322562 - VLV 3092281
VEHICLE	

GTM2.870 Caliper Cover Gasket



OEM NO	
VEHICLE	

GTM2.8043 Caliper Small Gear Mechanism - R



OEM NO	68322563 - VLV 3092280
VEHICLE	

GTM2.8049 Brake Pad Retainer Repair Kit



OEM NO	MCK1262 - MN 81.50822.0007 - RNLT 503128759
VEHICLE	

GTM2.800 Caliper Adjusting Gear - Ø 35 mm - R



OEM NO	
VEHICLE	

281.06 Caliper Lever Bearing



OEM NO	
VEHICLE	

GTM2.871 Caliper Lever - R



OEM NO	
VEHICLE	

GTM2.872 Caliper Lever - L



OEM NO	
VEHICLE	

GTM2.869 Caliper Cover Gasket

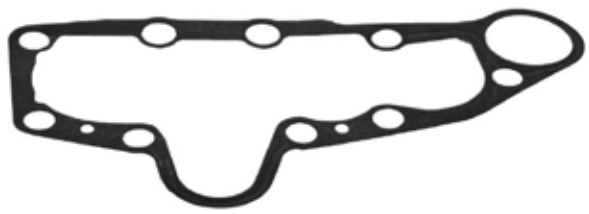

OEM NO	
VEHICLE	

MRT

ELSA 1

SM2009

Caliper Complete Repair Kit - (Without Lever) - L

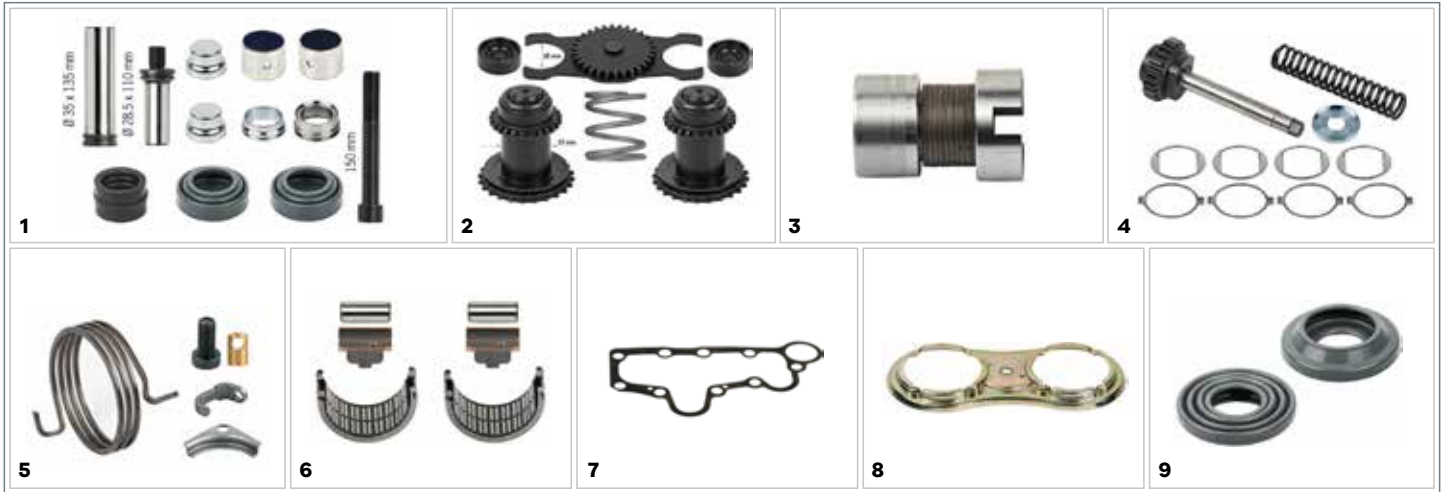

VEHICLE MAN BUS A13/A32 - MAN BUS LION'S CLASSIC - NEW Model

NR	GTSA KOD	DESCRIPTION	QTY	NR	GTSA KOD	DESCRIPTION	QTY
1	GTM2.853	Caliper Pin Repair Kit	1	6	GTM2.840	Caliper Bearing Set	1
2	GTM2.8071-1	Caliper Adjusting Gear Set - Ø35 mm - L	1	7	GTM2.868	Caliper Cover Gasket	1
3	GTM2.807	Caliper Mechanism Adjuster - (44 mm) L	1	8	GTM2.811	Caliper Adjusting Gear Locking Shim	1
4	GTM2.808	Caliper Manual Adjusting Gear	1	9	GTM2.847	Caliper Tappet Boot Set	1
5	GTM2.810-1	Caliper Lever Return Spring Set - L	1				

SM2008

Caliper Complete Repair Kit - (Without Lever) - R



VEHICLE MAN BUS A13/A32 - MAN BUS LION'S CLASSIC - NEW Model

NR	GTSA KOD	DESCRIPTION	QTY	NR	GTSA KOD	DESCRIPTION	QTY
1	GTM2.853	Caliper Pin Repair Kit	1	6	GTM2.840	Caliper Bearing Set	1
2	GTM2.8070-1	Caliper Adjusting Gear Set - Ø35 mm - R	1	7	GTM2.868	Caliper Cover Gasket	1
3	GTM2.806	Caliper Mechanism Adjuster - (44 mm) R	1	8	GTM2.811	Caliper Adjusting Gear Locking Shim	1
4	GTM2.808	Caliper Manual Adjusting Gear	1	9	GTM2.847	Caliper Tappet Boot Set	1
5	GTM2.809-1	Caliper Lever Return Spring Set - R	1				

SM2011

Caliper Complete Repair Kit - (Without Lever) - L



VEHICLE MAN BUS A13/A32 - MAN BUS LION'S CLASSIC - OLD Model

NR	GTSA KOD	DESCRIPTION	QTY	NR	GTSA KOD	DESCRIPTION	QTY
1	GTM2.853	Caliper Pin Repair Kit	1	6	GTM2.840	Caliper Bearing Set	1
2	GTM2.8071	Caliper Adjusting Gear Set - Ø37,50 mm - L	1	7	GTM2.869	Caliper Cover Gasket	1
3	GTM2.807	Caliper Mechanism Adjuster - (44 mm) L	1	8	GTM2.811	Caliper Adjusting Gear Locking Shim	1
4	GTM2.808	Caliper Manual Adjusting Gear	1	9	GTM2.847	Caliper Tappet Boot Set	1
5	GTM2.810-1	Caliper Lever Return Spring Set - L	1				

SM2010

Caliper Complete Repair Kit - (Without Lever) - R



VEHICLE MAN BUS A13/A32 - MAN BUS LION'S CLASSIC - OLD Model

NR	GTSA KOD	DESCRIPTION	QTY	NR	GTSA KOD	DESCRIPTION	QTY
1	GTM2.853	Caliper Pin Repair Kit	1	6	GTM2.840	Caliper Bearing Set	1
2	GTM2.8070	Caliper Adjusting Gear Set - Ø37,50 mm - R	1	7	GTM2.869	Caliper Cover Gasket	1
3	GTM2.806	Caliper Mechanism Adjuster - (44 mm) R	1	8	GTM2.811	Caliper Adjusting Gear Locking Shim	1
4	GTM2.808	Caliper Manual Adjusting Gear	1	9	GTM2.847	Caliper Tappet Boot Set	1
5	GTM2.809-1	Caliper Lever Return Spring Set - R	1				

MRT DX195

GTM2.861 Caliper Pin Repair Kit

OEM NO: MCK1171 - SCN AMMCK1171 - DF 1489989 - RNLT 5021 170 885

VEHICLE: ROR Axle LM/LCTM

NR	GTSA KOD	DESCRIPTION	QTY
1	251.08	Caliper Pin - Ø32x97-37 mm	1
2	251.09	Caliper Pin - Ø32x97-62 mm	1
3	155.01.01	Caliper Pin Bolt - M16x1,50x80 mm	1
4	255.09.01	Caliper Pin Bolt - M16x1,50x55mm	1
5	261.06	Caliper Pin Bush - Ø36xØ32x55 mm	2
6	271.05	Caliper Pin Cap - Ø42x28 mm	2
7	265.06	Caliper Pin Boot	2
8	265.05	Caliper Tappet Boot	2
9	265.05.01	Caliper Tappet Boot Seal	2
10	255.14.01	Caliper Tappet Bolt - M10x1,50x20 mm	2
11	255.15.01	Caliper End Plate Bolt - M12x1,75x20 mm	2
12	255.16.01	Caliper End Plate Bolt - M12x1,75x30 mm	4
13	255.17.01	Caliper Cover Plate Bolt - M8x1,25x20 mm	2
14	291.02	Caliper Cover Plate Gasket	1
15	255.18	Caliper Cover Plate Bolt - M8x1,25x20 mm	1
16	291.03	Caliper End Plate Plug Bolt Washer - Ø19xØ13 mm	1

GTM2.862 Caliper Boot & Pin Bolt Repair Kit

OEM NO: MCK1192 - SCN 1034001 - DF 1489991 - VLV AMMCK1192

VEHICLE:

NR	GTSA KOD	DESCRIPTION	QTY
1	155.01	Caliper Pin Bolt - M16x1,50x80 mm	1
2	255.09	Caliper Pin Bolt - M16x1,50x55mm	1
3	271.05	Caliper Pin Cap - Ø42x28 mm	2
4	265.06	Caliper Pin Boot	2
5	265.05	Caliper Tappet Boot	2
6	265.05.01	Caliper Tappet Boot Seal	2

GTM2.8058 Caliper Shaft & Cover Repair Kit

OEM NO: MCK1168 - MCK1169 - DF 1689883 - IVECO 2995922

VEHICLE:

NR	GTSA KOD	DESCRIPTION	QTY
1	2.898	Caliper Eccentric Shaft	1
2	291.55	Caliper Eccentric Shaft Bevel Washer	1
3	265.28	Caliper Eccentric Shaft Seal	1
4	265.33	Caliper Eccentric Shaft Dust Cover	1
5	281.04	Caliper Eccentric Shaft Central Bearing	1
6	2.8046	Caliper Cover Plate (With Needle Bearing)	1
7	265.34	Caliper Cover Plate Seal	1
8	255.17.01	Caliper Cover Plate Bolt - M8x1,25x20 mm	2
9	291.02	Caliper Cover Plate Gasket	1
10	255.18	Caliper End Plate Plug Bolt	1
11	291.03	Caliper End Plate Plug Bolt Washer - Ø19xØ13 mm	1

GTM2.8020 Caliper Repair Kit - R



OEM NO

VEHICLE

NR	GTSA KOD	DESCRIPTION	QTY
1	GTM2.8013	Caliper Shaft Housing - 163 mm	1
2	GTM2.8014	Caliper Piston & Pinion Repair Kit - R	2
3	GTM2.8062	Caliper Mechanism Central Fork & Pinion	1
4	291.04	Caliper Tappet Plate	1
5	2.8016	Caliper Calibration Bolt - R	2
6	255.14	Caliper Tappet Bolt - M10x1,50x20 mm	2

GTM2.8019 Caliper Mechanism Repair Kit - L



OEM NO

DSB5L - FRHF CF104620

VEHICLE

NR	GTSA KOD	DESCRIPTION	QTY
1	2.8019	Caliper Adjusting Mechanism - L	1
2	291.21	Caliper Adjuster Bolt	1
3	291.24	Caliper Adjuster Spring	1
4	291.22	Caliper Piston Wavy Washer	2
5	291.23	Caliper Piston Ring	2
6	291.25	Caliper Piston Seal	2

GTM2.8018 Caliper Mechanism Repair Kit - R



OEM NO

DSB5R - FRHF CF104619

VEHICLE

NR	GTSA KOD	DESCRIPTION	QTY
1	2.8018	Caliper Adjusting Mechanism - R	1
2	291.21	Caliper Adjuster Bolt	1
3	291.24	Caliper Adjuster Spring	1
4	291.22	Caliper Piston Wavy Washer	2
5	291.23	Caliper Piston Ring	2
6	291.25	Caliper Piston Seal	2

MRT

DX195

GTM2.8023

Caliper Mechanism Repair Kit - L



OEM NO

MCK1290 - DF 0876050 - VLV AMMCK1290

VEHICLE

NR	GTSA KOD	DESCRIPTION	QTY
1	2.8019	Caliper Adjusting Mechanism - L	1
2	291.21	Caliper Adjuster Bolt	1
3	291.24	Caliper Adjuster Spring	1
4	291.22	Caliper Piston Wavy Washer	2
5	291.23	Caliper Piston Ring	2
6	291.25	Caliper Piston Seal	2
7	GTM2.8062	Caliper Mechanism Central Fork & Pinion	1
8	255.15.01	Caliper End Plate Bolt - M12x1,75x20 mm	2
9	255.16.01	Caliper End Plate Bolt - M12x1,75x30 mm	6
10	255.18	Caliper End Plate Plug Bolt	1
11	291.03	Caliper End Plate Plug Bolt Washer - Ø19xØ13 mm	1

GTM2.8022

Caliper Mechanism Repair Kit - R



OEM NO

MCK1291 - DF 0876051 - VLV AMMCK1291 - CTRPLR 2799438

VEHICLE

NR	GTSA KOD	DESCRIPTION	QTY
1	2.8018	Caliper Adjusting Mechanism - R	1
2	291.21	Caliper Adjuster Bolt	1
3	291.24	Caliper Adjuster Spring	1
4	291.22	Caliper Piston Wavy Washer	2
5	291.23	Caliper Piston Ring	2
6	291.25	Caliper Piston Seal	2
7	GTM2.8062	Caliper Mechanism Central Fork & Pinion	1
8	255.15.01	Caliper End Plate Bolt - M12x1,75x20 mm	2
9	255.16.01	Caliper End Plate Bolt - M12x1,75x30 mm	6
10	255.18	Caliper End Plate Plug Bolt	1
11	291.03	Caliper End Plate Plug Bolt Washer - Ø19xØ13 mm	1

GTM2.8021

Caliper Repair Kit - L



OEM NO

VEHICLE

NR	GTSA KOD	DESCRIPTION	QTY
1	GTM2.8013	Caliper Shaft Housing - 163 mm	1
2	GTM2.8015	Caliper Piston & Pinion Repair Kit - L	2
3	GTM2.8062	Caliper Mechanism Central Fork & Pinion	1
4	291.04	Caliper Tappet Plate	1
5	2.8017	Caliper Calibration Bolt - L	2
6	255.14	Caliper Tappet Bolt - M10x1,50x20 mm	2

GTM2.8046 Caliper Shaft & Cover Repair Kit



OEM NO

VEHICLE

NR	GTSA KOD	DESCRIPTION	QTY
1	2.8046	Caliper Cover Plate (With Needle Bearing)	1
2	265.34	Caliper Cover Plate Seal	1
3	255.17.01	Caliper Cover Plate Bolt - M8x1,25x20 mm	2
4	291.02	Caliper Cover Plate Gasket	1

GTM2.8085 Caliper Bearing Set



OEM NO

MCK1344 - ASTR 98133545AS - CTRPLLR 3429202

VEHICLE

NR	GTSA KOD	DESCRIPTION	QTY
1	281.05	Caliper Needle Bearing - Ø52xØ46x20 mm	2
2	281.04	Caliper Eccentric Shaft Central Bearing	1
3	261.23	Caliper Shaft Housing Bearing Sleeve - Ø72xØ68x28 mm	1

GTM2.8060 Caliper Shaft Housing & Piston Set - L



OEM NO

DSB6L

VEHICLE

NR	GTSA KOD	DESCRIPTION	QTY
1	GTM2.8013	Caliper Shaft Housing - 163 mm	1
2	GTM2.8015	Caliper Piston & Pinion Repair Kit - L	2
3	GTM2.8062	Caliper Mechanism Central Fork & Pinion	1

MRT

DX195

GTM2.8059 Caliper Shaft Housing & Piston Set - R



OEM NO DSB6R

VEHICLE

NR	GTSA KOD	DESCRIPTION	QTY
1	GTM2.8013	Caliper Shaft Housing - 163 mm	1
2	GTM2.8014	Caliper Piston & Pinion Repair Kit - R	2
3	GTM2.8062	Caliper Mechanism Central Fork & Pinion	1

GTM2.8016 Caliper Tappet Plate Repair Kit - R



OEM NO

VEHICLE

NR	GTSA KOD	DESCRIPTION	QTY
1	291.04	Caliper Tappet Plate	1
2	2.8016	Caliper Calibration Bolt - R	2
3	255.14	Caliper Tappet Bolt - M10x1,50x20 mm	2

GTM2.862-1 Caliper Boot Set



NR	GTSA KOD	DESCRIPTION	QTY
1	265.06	Caliper Pin Boot	2
2	265.05	Caliper Tappet Boot	2
3	265.05.01	Caliper Tappet Boot Seal	2

GTM2.8017 Caliper Tappet Plate Repair Kit - L



NR	GTSA KOD	DESCRIPTION	QTY
1	291.04	Caliper Tappet Plate	1
2	2.8017	Caliper Calibration Bolt - L	2
3	255.14	Caliper Tappet Bolt - M10x1,50x20 mm	2

GTM2.8057

Caliper Cover Plate Seal Set



NR	GTSA KOD	DESCRIPTION	QTY
1	265.34	Caliper Cover Plate Seal	5

GTM2.8026

Caliper Eccentric Shaft Bevel Washer Set



NR	GTSA KOD	DESCRIPTION	QTY
1	291.55	Caliper Eccentric Shaft Bevel Washer	5

GTM2.8056

Caliper Eccentric Shaft Dust Cover Set



NR	GTSA KOD	DESCRIPTION	QTY
1	265.33	Caliper Eccentric Shaft Dust Cover	1

GTM2.898

Caliper Eccentric Shaft Set



NR	GTSA KOD	DESCRIPTION	QTY
1	2.898	Caliper Eccentric Shaft	1
2	265.28	Caliper Eccentric Shaft Seal	1

GTM2.8045

Caliper Lever - 90 mm



OEM NO	MCK1161 - MN N2509990223 - STRMCK1161 - DF 1675766 - VLV AMMCK1161
VEHICLE	

GTM2.8047

Brake Pad Retainer Bar



OEM NO	2297J6692
VEHICLE	

MRT

DX195

GTM2.8062 Caliper Mechanism Central Fork & Pinion



OEM NO (3280-C-9241-D) - (3280-Z-93360-B)

VEHICLE

GTM2.8013 Caliper Shaft Housing - 163 mm



OEM NO

VEHICLE

281.05 Caliper Needle Bearing - Ø52xØ46x20 mm



OEM NO

VEHICLE

GTM2.8015 Caliper Piston & Pinion Repair Kit - L



OEM NO

VEHICLE

GTM2.8007 Brake Pad Retainer Repair Kit



OEM NO

VEHICLE

GTM2.8014 Caliper Piston & Pinion Repair Kit - R



OEM NO

VEHICLE

SM2016 Caliper Complete Repair Kit - L



VEHICLE	ROR Axle LM / LC / TM
----------------	-----------------------

NR	GTSA KOD	DESCRIPTION	QTY	NR	GTSA KOD	DESCRIPTION	QTY
1	GTM2.861	Caliper Pin Repair Kit	1	8	265.28	Caliper Eccentric Shaft Seal	1
2	GTM2.8060	Caliper Shaft Housing & Piston Set - L	1	9	281.04	Caliper Eccentric Shaft Central Bearing	1
3	GTM2.8019	Caliper Mechanism Repair Kit - L	1	10	291.55	Caliper Eccentric Shaft Bevel Washer	1
4	291.04	Caliper Tappet Plate	1	11	2.8046	Caliper Cover Plate (With Needle Bearing)	1
5	2.8017	Caliper Calibration Bolt - L	2	12	265.34	Caliper Cover Plate Seal	1
6	2.898	Caliper Eccentric Shaft	1	13	265.33	Caliper Eccentric Shaft Dust Cover	1
7	281.05	Caliper Needle Bearing - Ø52xØ46x20 mm	1	14	GTM2.8045	Caliper Lever - 90 mm	1

SM2015 Caliper Complete Repair Kit - R



VEHICLE	ROR Axle LM / LC / TM
----------------	-----------------------

NR	GTSA KOD	DESCRIPTION	QTY	NR	GTSA KOD	DESCRIPTION	QTY
1	GTM2.861	Caliper Pin Repair Kit	1	8	265.28	Caliper Eccentric Shaft Seal	1
2	GTM2.8059	Caliper Shaft Housing & Piston Set - R	1	9	281.04	Caliper Eccentric Shaft Central Bearing	1
3	GTM2.8018	Caliper Mechanism Repair Kit - R	1	10	291.55	Caliper Eccentric Shaft Bevel Washer	1
4	291.04	Caliper Tappet Plate	1	11	2.8046	Caliper Cover Plate (With Needle Bearing)	1
5	2.8016	Caliper Calibration Bolt - R	2	12	265.34	Caliper Cover Plate Seal	1
6	2.898	Caliper Eccentric Shaft	1	13	265.33	Caliper Eccentric Shaft Dust Cover	1
7	281.05	Caliper Needle Bearing - Ø52xØ46x20 mm	1	14	GTM2.8045	Caliper Lever - 90 mm	1

All manufacturer names, trademarks, product descriptions contained in this product catalog are for reference only. All reference numbers are for comparison purposes.

MRT

DX225

GTM2.8074

Caliper Pin Repair Kit



OEM NO

MCK1172 - BRDMNRNBS 193101

VEHICLE

IRISBUS CITYBUS - BREDAMENARINI BUS

NR	GTSA KOD	DESCRIPTION	QTY
1	251.25	Caliper Pin - Ø35x98-68 mm	1
2	251.24	Caliper Pin - Ø35x98-35 mm	1
3	255.28	Caliper Pin Bolt - M18x2,50x90 mm	1
4	255.29	Caliper Pin Bolt - M18x2,50x55 mm	1
5	261.34	Caliper Pin Bush - Ø39xØ35x50 mm	2
6	271.09	Caliper Pin Cap - Ø42x31 mm	2
7	271.10	Caliper Pin Cap - Ø37x15mm	1
8	265.21	Caliper Pin Boot	2
9	265.22	Caliper Tappet Boot	2
10	265.23	Caliper Tappet Boot Seal	2
11	255.14	Caliper Tappet Bolt - M10x1,50x20 mm	2
12	255.15	Caliper End Plate Bolt - M12x1,75x20 mm	2
13	255.16	Caliper End Plate Bolt - M12x1,75x30 mm	4
14	255.17	Caliper Cover Plate Bolt - M8x1,25x20 mm	2
15	291.02	Caliper Cover Plate Gasket	1
16	255.18	Caliper End Plate Plug Bolt	1
17	291.03	Caliper End Plate Plug Bolt Washer - Ø19xØ13 mm	1

GTM2.8079

Caliper Pin Repair Kit



OEM NO

VEHICLE

NR	GTSA KOD	DESCRIPTION	QTY
1	251.25	Caliper Pin - Ø35x98-68 mm	1
2	251.24	Caliper Pin - Ø35x98-35 mm	1
3	255.28	Caliper Pin Bolt - M18x2,50x90 mm	1
4	255.29	Caliper Pin Bolt - M18x2,50x55 mm	1
5	261.34	Caliper Pin Bush - Ø39xØ35x50 mm	2
6	271.09	Caliper Pin Cap - Ø42x31 mm	2

GTM2.8058

Caliper Shaft & Cover Repair Kit



OEM NO

MCK1168 - MCK1169 - DF 1689883 - IVECO 2995922 - RNL 5021 202 850

VEHICLE

NR	GTSA KOD	DESCRIPTION	QTY
1	2.898	Caliper Eccentric Shaft	1
2	291.55	Caliper Eccentric Shaft Bevel Washer	1
3	265.28	Caliper Eccentric Shaft Seal	1
4	265.33	Caliper Eccentric Shaft Dust Cover	1
5	281.04	Caliper Eccentric Shaft Central Bearing	1
6	2.8046	Caliper Cover Plate (With Needle Bearing)	1
7	265.34	Caliper Cover Plate Seal	1
8	255.17	Caliper Cover Plate Bolt - M8x1,25x20 mm	2
9	291.02	Caliper Cover Plate Gasket	1
10	255.18	Caliper End Plate Plug Bolt	1
11	291.03	Caliper End Plate Plug Bolt Washer - Ø19xØ13 mm	1

GTM2.8072 Caliper Boot & Pin Bolt Repair Kit



OEM NO MCK1193 - BRDMNRNBS 193102

VEHICLE

NR	GTSA KOD	DESCRIPTION	QTY
1	255.28	Caliper Pin Bolt - M18x2,50x90 mm	1
2	255.29	Caliper Pin Bolt - M18x2,50x55 mm	1
3	271.09	Caliper Pin Cap - Ø42x31 mm	2
4	265.21	Caliper Pin Boot	2
5	265.22	Caliper Tappet Boot	2
6	265.23	Caliper Tappet Boot Seal	2

GTM2.8082 Caliper Mechanism Repair Kit - L



OEM NO

VEHICLE

NR	GTSA KOD	DESCRIPTION	QTY
1	2.8082	Caliper Adjusting Mechanism - L	1
2	291.21	Caliper Adjuster Bolt	1
3	291.24	Caliper Adjuster Spring	1
4	291.22	Caliper Piston Wavy Washer	2
5	291.23	Caliper Piston Ring	2
6	291.25	Caliper Piston Seal	2

GTM2.8081 Caliper Mechanism Repair Kit - R



OEM NO

VEHICLE

NR	GTSA KOD	DESCRIPTION	QTY
1	2.8081	Caliper Adjusting Mechanism - R	1
2	291.21	Caliper Adjuster Bolt	1
3	291.24	Caliper Adjuster Spring	1
4	291.22	Caliper Piston Wavy Washer	2
5	291.23	Caliper Piston Ring	2
6	291.25	Caliper Piston Seal	2

MRT

DX225

GTM2.8046 Caliper Shaft & Cover Repair Kit



OEM NO	
VEHICLE	

NR	GTSA KOD	DESCRIPTION	QTY
1	2.8046	Caliper Cover Plate (With Needle Bearing)	1
2	265.34	Caliper Cover Plate Seal	1
3	255.17	Caliper Cover Plate Bolt - M8x1,25x20 mm	2
4	291.02	Caliper Cover Plate Gasket	1

GTM2.8085 Caliper Bearing Set



OEM NO	MCK1344 - ASTR 98133545AS - CTRPLLR 3429202 - BRDMNRNBS 193107
VEHICLE	

NR	GTSA KOD	DESCRIPTION	QTY
1	281.05	Caliper Needle Bearing - Ø52xØ46x20 mm	2
2	281.04	Caliper Eccentric Shaft Central Bearing	1
3	261.23	Caliper Shaft Housing Bearing Sleeve - Ø72xØ68x28 mm	1

GTM2.8077 Caliper Tappet Plate Repair Kit - L



NR	GTSA KOD	DESCRIPTION	QTY
1	291.54	Caliper Tappet Plate	1
2	2.8017	Caliper Calibration Bolt - L	2
3	255.14	Caliper Tappet Bolt - M10x1,50x20 mm	2

GTM2.8078 Caliper Tappet Plate Repair Kit - R



NR	GTSA KOD	DESCRIPTION	QTY
1	291.54	Caliper Tappet Plate	1
2	2.8016	Caliper Calibration Bolt - R	2
3	255.14	Caliper Tappet Bolt - M10x1,50x20 mm	2

GTM2.8057 Caliper Cover Plate Seal Set



NR	GTSA KOD	DESCRIPTION	QTY
1	265.34	Caliper Cover Plate Seal	5

GTM2.8056 Caliper Eccentric Shaft Dust Cover Set



NR	GTSA KOD	DESCRIPTION	QTY
1	265.33	Caliper Eccentric Shaft Dust Cover	1

GTM2.898 Caliper Eccentric Shaft Set



NR	GTSA KOD	DESCRIPTION	QTY
1	2.898	Caliper Eccentric Shaft	1
2	265.28	Caliper Eccentric Shaft Seal	1

GTM2.8045 Caliper Lever - 90 mm



OEM NO	MCK1161 - MN N2509990223 - STRMCK1161 - DF 1675766 - VLV AMMCK1161
VEHICLE	

GTM2.8080 Caliper Shaft Housing - 169 mm



OEM NO	
VEHICLE	

281.05 Caliper Needle Bearing - Ø52xØ46x20 mm



OEM NO	
VEHICLE	

MRT

DX225

GTM2.8062 Caliper Mechanism Central Fork & Pinion



OEM NO (3280-C-9241-D) - (3280-Z-93360-B)

VEHICLE

GTM2.8026 Caliper Eccentric Shaft Bevel Washer Set



OEM NO

VEHICLE

GTM2.8075 Caliper Piston & Pinion Repair Kit - L



OEM NO

VEHICLE

GTM2.8076 Caliper Piston & Pinion Repair Kit - R



OEM NO

VEHICLE

GTM2.8096 Caliper End Plate Gasket

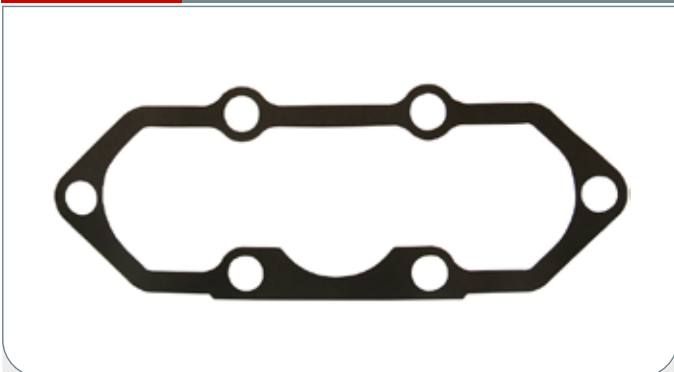

OEM NO

VEHICLE

SM2022

Caliper Complete Repair Kit - L



VEHICLE IRISBUS CITYBUS - BREDAMENARINI BUS

NR	GTSA KOD	DESCRIPTION	QTY
1	GTM2.8074	Caliper Pin Repair Kit	1
2	GTM2.8080	Caliper Shaft Housing - 169 mm	1
3	GTM2.8075	Caliper Piston & Pinion Repair Kit - L	2
4	GTM2.8062	Caliper Mechanism Central Fork & Pinion	1
5	GTM2.8082	Caliper Mechanism Repair Kit - L	1
6	GTM2.8077	Caliper Tappet Plate Repair Kit - L	1
7	2.898	Caliper Eccentric Shaft	1
8	281.05	Caliper Needle Bearing - Ø52xØ46x20 mm	1

NR	GTSA KOD	DESCRIPTION	QTY
9	265.28	Caliper Eccentric Shaft Seal	1
10	281.04	Caliper Eccentric Shaft Central Bearing	1
11	291.55	Caliper Eccentric Shaft Bevel Washer	1
12	2.8046	Caliper Cover Plate (With Needle Bearing)	1
13	265.34	Caliper Cover Plate Seal	1
14	265.33	Caliper Eccentric Shaft Dust Cover	1
15	GTM2.8045	Caliper Lever - 90 mm	1

SM2021

Caliper Complete Repair Kit - R



VEHICLE IRISBUS CITYBUS - BREDAMENARINI BUS

NR	GTSA KOD	DESCRIPTION	QTY
1	GTM2.8074	Caliper Pin Repair Kit	1
2	GTM2.8080	Caliper Shaft Housing - 169 mm	1
3	GTM2.8076	Caliper Piston & Pinion Repair Kit - R	2
4	GTM2.8062	Caliper Mechanism Central Fork & Pinion	1
5	GTM2.8081	Caliper Mechanism Repair Kit - R	1
6	GTM2.8078	Caliper Tappet Plate Repair Kit - R	1
7	2.898	Caliper Eccentric Shaft	1
8	281.05	Caliper Needle Bearing - Ø52xØ46x20 mm	1

NR	GTSA KOD	DESCRIPTION	QTY
9	265.28	Caliper Eccentric Shaft Seal	1
10	281.04	Caliper Eccentric Shaft Central Bearing	1
11	291.55	Caliper Eccentric Shaft Bevel Washer	1
12	2.8046	Caliper Cover Plate (With Needle Bearing)	1
13	265.34	Caliper Cover Plate Seal	1
14	265.33	Caliper Eccentric Shaft Dust Cover	1
15	GTM2.8045	Caliper Lever - 90 mm	1

MRT DUCO

GTM2.881-2

Caliper Pin Repair Kit



OEM NO

MCK1134 - SJ4094 - DF 1489198 - VLV 3092255

VEHICLE

VOLVO FH12/FH16 - VOLVO FM9 /FM10/FM12/FMX - VOLVO FL6/FM7
- VOLVO BUS B12B

NR	GTSA KOD	DESCRIPTION	QTY
1	251.05	Caliper Pin - Ø35x102 mm	1
2	251.15	Caliper Pin - Ø35x60 mm	1
3	255.03	Caliper Pin Bolt - M20x2,00x125 mm	1
4	255.20	Caliper Pin Bolt - M20x2,00x80 mm	1
5	261.24	Caliper Pin Fiber Bush - Ø39xØ35x38 mm	2
6	261.03	Caliper Pin Oval Bush - Ø39xØ36-35x30 mm	1
7	275.07	Caliper Pin Boot Ring - Ø40xØ37x11 mm	2
8	271.04	Caliper Pin Cap - Ø40x18,50 mm	2
9	265.03	Caliper Pin Boot	2

GTM2.881-1

Caliper Pin Repair Kit



OEM NO

MN STRMCK1116 - DF 1489197 - MRT MCK1116 - VLV 85102094

VEHICLE

VOLVO FH12/FH16 - VOLVO FM9 /FM10/FM12/FMX - VOLVO BUS B12B

NR	GTSA KOD	DESCRIPTION	QTY
1	251.05	Caliper Pin - Ø35x102 mm	1
2	251.15	Caliper Pin - Ø35x60 mm	1
3	255.03	Caliper Pin Bolt - M20x2,00x125 mm	1
4	255.20	Caliper Pin Bolt - M20x2,00x80 mm	1
5	261.12	Caliper Pin Fiber Bush - Ø39xØ35x77 mm	1
6	261.03	Caliper Pin Oval Bush - Ø39xØ36-35x30 mm	1
7	275.07	Caliper Pin Boot Ring - Ø40xØ37x11 mm	2
8	271.04	Caliper Pin Cap - Ø40x18,50 mm	2
9	265.03	Caliper Pin Boot	2

GTM2.881

Caliper Pin Repair Kit



OEM NO

BRASS BUSH TYPE FOR MCK1116

VEHICLE

NR	GTSA KOD	DESCRIPTION	QTY
1	251.05	Caliper Pin - Ø35x102 mm	1
2	251.15	Caliper Pin - Ø35x60 mm	1
3	255.03	Caliper Pin Bolt - M20x2,00x125 mm	1
4	255.20	Caliper Pin Bolt - M20x2,00x80 mm	1
5	261.04	Caliper Pin Bush - Ø40xØ35x77 mm	1
6	261.03	Caliper Pin Oval Bush - Ø39xØ36-35x30 mm	1
7	275.07	Caliper Pin Boot Ring - Ø40xØ37x11 mm	2
8	271.04	Caliper Pin Cap - Ø40x18,50 mm	2
9	265.03	Caliper Pin Boot	2

GTM2.882 Caliper Pin Repair Kit

OEM NO: MCK1229 - MN STRMCK1299 - VLV 3092268 - 3095629

VEHICLE: VOLVO FH12/FH16 - VOLVO FM9 /FM10/FM12 - VOLVO BUS B7L / B12B / B12M

NR	GTSA KOD	DESCRIPTION	QTY
1	251.05	Caliper Pin - Ø35x102 mm	1
2	255.03	Caliper Pin Bolt - M20x2,00x125 mm	2
3	255.20	Caliper Pin Bolt - M20x2,00x80 mm	1
4	271.04	Caliper Pin Cap - Ø40x18,50 mm	2
5	265.03	Caliper Pin Boot	2

GTM2.8119 Caliper Pin Repair Kit

OEM NO: MCK1135 - SJ4107 - DF 1522166 - VLV 3092256 - 3096788 - 85103891

VEHICLE: VOLVO FH12/FH16 - VOLVO FM9 /FM10/FM12/FMX - VOLVO FL6/FM7

NR	GTSA KOD	DESCRIPTION	QTY
1	251.05	Caliper Pin - Ø35x102 mm	2
2	255.03	Caliper Pin Bolt - M20x2,00x125 mm	2
3	261.24	Caliper Pin Fiber Bush - Ø39xØ35x38 mm	2
4	261.03	Caliper Pin Oval Bush - Ø39xØ36-35x30 mm	2
5	275.07	Caliper Pin Boot Ring - Ø40xØ37x11 mm	2
6	271.04	Caliper Pin Cap - Ø40x18,50 mm	2
7	265.03	Caliper Pin Boot	2

GTM2.860-1 Caliper Pin Repair Kit

OEM NO: MCK1118 - VLV 85102092

VEHICLE: VOLVO FH12/FH16 - VOLVO FM9 /FM10/FM12/FMX - VOLVO FL6/ FM7 - VOLVO BUS B12M

NR	GTSA KOD	DESCRIPTION	QTY
1	251.05	Caliper Pin - Ø35x102 mm	2
2	255.03	Caliper Pin Bolt - M20x2,00x125 mm	2
3	261.12	Caliper Pin Fiber Bush - Ø39xØ35x77 mm	1
4	261.03	Caliper Pin Oval Bush - Ø39xØ36-35x30 mm	2
5	275.07	Caliper Pin Boot Ring - Ø40xØ37x11 mm	2
6	271.04	Caliper Pin Cap - Ø40x18,50 mm	2
7	265.03	Caliper Pin Boot	2

MRT DUCO

GTM2.860 Caliper Pin Repair Kit

OEM NO BRASS BUSH TYPE FOR MCK1118

VEHICLE

NR	GTSA KOD	DESCRIPTION	QTY
1	251.05	Caliper Pin - Ø35x102 mm	2
2	255.03	Caliper Pin Bolt - M20x2,00x125 mm	2
3	261.04	Caliper Pin Bush - Ø40xØ35x77 mm	1
4	261.03	Caliper Pin Oval Bush - Ø39xØ36-35x30 mm	2
5	275.07	Caliper Pin Boot Ring - Ø40xØ37x11 mm	2
6	271.04	Caliper Pin Cap - Ø40x18,50 mm	2
7	265.03	Caliper Pin Boot	2

GTM2.860-3 Caliper Boot & Pin Repair Kit

OEM NO BRASS BUSH TYPE FOR MCK1118

VEHICLE

NR	GTSA KOD	DESCRIPTION	QTY
1	251.05	Caliper Pin - Ø35x102 mm	2
2	255.03	Caliper Pin Bolt - M20x2,00x125 mm	2
3	261.04	Caliper Pin Bush - Ø40xØ35x77 mm	1
4	261.03	Caliper Pin Oval Bush - Ø39xØ36-35x30 mm	2
5	275.07	Caliper Pin Boot Ring - Ø40xØ37x11 mm	2
6	271.04	Caliper Pin Cap - Ø40x18,50 mm	2
7	265.03	Caliper Pin Boot	2
8	265.01	Caliper Tappet Boot	2

GTM2.883 Caliper Pin Repair Kit

OEM NO MCK1065 - MCK1066

VEHICLE

NR	GTSA KOD	DESCRIPTION	QTY
1	251.05	Caliper Pin - Ø35x102 mm	1
2	271.04	Caliper Pin Cap - Ø40x18,50 mm	2
3	265.03	Caliper Pin Boot	2

GTM2.8106 Caliper Adjusting Mechanism Shaft Set



OEM NO MCK1050 - VLV 3095646

VEHICLE VOLVO FL6 L MIDIUM

NR	GTSA KOD	DESCRIPTION	QTY
1	2.8106	Caliper Adjusting Mechanism Shaft	1
2	291.50	Caliper Mechanism Bearing - External Tooth	1
3	291.51	Caliper Mechanism Bering - Flat	1
4	291.52	Caliper Mechanism Thrust Bearing	1
5	291.53	Caliper Mechanism Thrust Washer	2

GTM2.8010 Caliper Visual Indicator

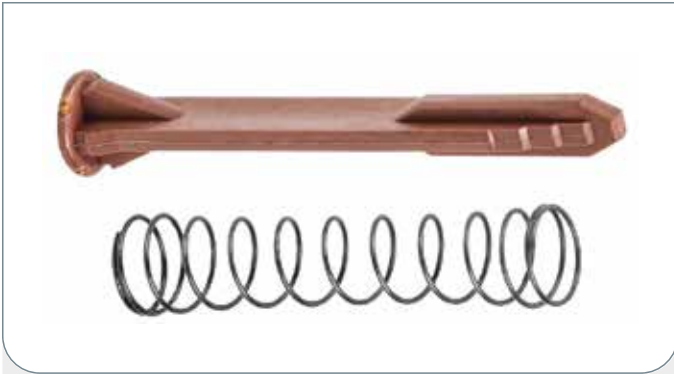

OEM NO SJ4111 - VLV 3092283

VEHICLE

NR	GTSA KOD	DESCRIPTION	QTY
1	291.30	Caliper Visual Indicator	1
2	291.20	Caliper Visual Indicator Spring-Ø16x80	1

GTM2.850 Caliper Tappet & Boot Set



OEM NO MN STRMCK1238 - DF 868378 - MCK1238 - VLV 3092264

VEHICLE

NR	GTSA KOD	DESCRIPTION	QTY
1	265.01	Caliper Tappet Boot	2
2	268.01	Caliper Tappet	2
3	291.05	Caliper Tappet Clips	2

MRT DUCO

GTM2.855 Caliper Adjusting Mechanism Set - L	
	
OEM NO	MCK1236 - VLV 3092262
VEHICLE	

NR	GTSA KOD	DESCRIPTION	QTY
1	GTM2.850	Caliper Tappet & Boot Set	1
2	2.855	Caliper Adjusting Mechanism - L	2
3	2.8556-4	Caliper Adjusting Fiber Bush - Ø49xØ45x30 mm	2
4	291.17	Caliper Adjusting Mechanism Seal	2

GTM2.856 Caliper Adjusting Mechanism Set - L	
	
OEM NO	MCK1237 - MCK1239 - VLV 3092263 - 3095642
VEHICLE	

NR	GTSA KOD	DESCRIPTION	QTY
1	GTM2.850	Caliper Tappet & Boot Set	1
2	2.856	Caliper Adjusting Mechanism - R	2
3	2.8556-4	Caliper Adjusting Fiber Bush - Ø49xØ45x30 mm	2
4	291.17	Caliper Adjusting Mechanism Seal	2

GTM2.8092 Caliper Intermediate Gear & Spring Set	
	
OEM NO	MCK1129 - VLV 85102099
VEHICLE	VOLVO FH12/FH16 - VOLVO FM9 /FM10/FM12/FMX - VOLVO FL6

NR	GTSA KOD	DESCRIPTION	QTY
1	2.8092	Caliper Intermediate Gear	1
2	291.65	Mechanism Friction Spring	1
3	291.66	Machanism Return Spring	1

GTM2.841 Caliper Intermediate Gear & Spring Set



OEM NO	MCK1067 - VLV 3095626
VEHICLE	VOLVO FH12/FH16 - VOLVO FM9 /FM10/FM12/FMX - VOLVO BUS B7L/ B12B/B12M

NR	GTSA KOD	DESCRIPTION	QTY
1	2.841	Caliper Intermediate Gear	1
2	291.19	Mechanism Friction Spring	1
3	291.18	Machanism Return Spring	1

GTM2.843 Caliper Adjusting Mechanism Shaft Set - R / L



OEM NO	MCK1113 - SJ4110
VEHICLE	VOLVO FH12/FH16 - VOLVO FM9 /FM10/FM12/FMX - VOLVO FL6/FM/7 - VOLVO BUS B12M

NR	GTSA KOD	DESCRIPTION	QTY
1	2.843	Caliper Adjusting Mechanism Shaft Set - R / L	1
2	265.10	Caliper Actuator Seal	1
3	265.13	Caliper Manual Adjusting Shaft Seal	1

GTM2.846 Caliper Adjusting Mechanism Shaft Set - L



OEM NO	SJ4102 - MCK1111 - VLV 3092265 - 85102095
VEHICLE	VOLVO FH12/FH16 - VOLVO FM9 /FM10/FM12/FMX - BUS B7L/B12B/ B12M

NR	GTSA KOD	DESCRIPTION	QTY
1	2.846	Caliper Adjusting Mechanism Shaft Set - L	1
2	265.13	Caliper Manual Adjusting Shaft Seal	1

MRT DUCO

GTM2.840 Caliper Bearing Set	
	
OEM NO	DF 1522169 - SJ4112 - VLV 3092329
VEHICLE	VOLVO FH12/FH16 - VOLVO FM9/FM12/FMX - VOLVO BUS B7/B12

NR	GTSA KOD	DESCRIPTION	QTY
1	GTM2.839	Caliper Needle Bearing Set	1
2	281.03	Caliper Lever Roller Bearing	2
3	281.02	Caliper Lever Bearing	2

GTM2.839 Caliper Needle Bearing Set	
	
OEM NO	DF 1522169 - SJ4112 - VLV 3092329
VEHICLE	VOLVO FH12/FH16 - VOLVO FM9/FM12/FMX - VOLVO BUS B7/B12

NR	GTSA KOD	DESCRIPTION	QTY
1	281.01	Caliper Needle Bearing	2

GTM2.845 Caliper Adjusting Mechanism Shaft Set - R	
	
OEM NO	SJ4103 - MCK1112 - VLV 3092266 - 85102096
VEHICLE	VOLVO FH12/FH16 - VOLVO FM9 /FM10/FM12/FMX - BUS B7L/B12B/ B12M

NR	GTSA KOD	DESCRIPTION	QTY
1	2.845	Caliper Adjusting Mechanism Shaft Set - L	1
2	265.13	Caliper Manual Adjusting Shaft Seal	1

GTM2.8107 Caliper Lever Set



OEM NO MCK1048

VEHICLE

NR	GTSA KOD	DESCRIPTION	QTY
1	2.8107	Caliper Lever	1
2	281.03	Caliper Lever Roller Bearing	2
3	281.01	Caliper Needle Bearing	2
4	265.10	Caliper Actuator Seal	1

GTM2.8065 Caliper Lever Set - L



OEM NO MCK1127 - VLV 85102097 - 85109978

VEHICLE

NR	GTSA KOD	DESCRIPTION	QTY
1	2.8065	Caliper Lever - L	1
2	281.03	Caliper Lever Roller Bearing	2
3	281.01	Caliper Needle Bearing	2
4	265.10	Caliper Actuator Seal	1

GTM2.8064 Caliper Lever Set - R



OEM NO MCK1128 - VLV 85102098 - 85109979

VEHICLE

NR	GTSA KOD	DESCRIPTION	QTY
1	2.8064	Caliper Lever - R	1
2	281.03	Caliper Lever Roller Bearing	2
3	281.01	Caliper Needle Bearing	2
4	265.10	Caliper Actuator Seal	1

MRT DUCO

GTM2.8009 Caliper Lever Set - L



OEM NO SJ4096 - MCK1398 - VLV 3092258 - 21109753 - 85109975

VEHICLE

NR	GTSA KOD	DESCRIPTION	QTY
1	2.8009	Caliper Lever - L	1
2	281.03	Caliper Lever Roller Bearing	2
3	281.01	Caliper Needle Bearing	2
4	265.10	Caliper Actuator Seal	1

GTM2.8008 Caliper Lever Set - R



OEM NO SJ4097 - MCK1399 - VLV 3092259 - 21109754 - 85109976

VEHICLE

NR	GTSA KOD	DESCRIPTION	QTY
1	2.8008	Caliper Lever - R	1
2	281.03	Caliper Lever Roller Bearing	2
3	281.01	Caliper Needle Bearing	2
4	265.10	Caliper Actuator Seal	1

GTM2.840-1 Caliper Bearing Set



OEM NO SJ4098 - VLV 3092261

VEHICLE

NR	GTSA KOD	DESCRIPTION	QTY
1	GTM2.839	Caliper Needle Bearing Set	1
2	281.03	Caliper Lever Roller Bearing	2
3	281.06	Caliper Lever Bearing	2

GTM2.8042 Caliper Lever Set



OEM NO SJ4108 - DF 1522167 - VLV 3092260 - 21109755 - 85109977

VEHICLE

NR	GTSA KOD	DESCRIPTION	QTY
1	2.8042	Caliper Lever	1
2	281.03	Caliper Lever Roller Bearing	2
3	281.01	Caliper Needle Bearing	2
4	265.10	Caliper Actuator Seal	1

GTM2.885 Caliper Cover Gasket Set



OEM NO MCK1041 - VLV 3095669

VEHICLE VOLVO FH12 - VOLVO FM9/FM12 - VOLVO FL6

NR	GTSA KOD	DESCRIPTION	QTY
1	2.885	Caliper Cover Gasket	1
2	265.11	Caliper Rubber Cap	1
3	265.10	Caliper Actuator Seal	1
4	265.13	Caliper Manual Adjusting Shaft Seal	1

GTM2.884 Caliper Cover Gasket Set



OEM NO SJ4109 - DF 1522168 - VLV 3092270

VEHICLE VOLVO FH12/FH16 - VOLVO FM9/FM10/ FM12 - VOLVO FL6/FM7- VOLVO BUS B7L / B12B / B12M

NR	GTSA KOD	DESCRIPTION	QTY
1	2.884	Caliper Cover Gasket	1
2	265.12	Caliper Rubber Cap	1
3	265.10	Caliper Actuator Seal	1
4	265.13	Caliper Manual Adjusting Shaft Seal	1

MRT DUCO

GTM2.851 Caliper Cover Gasket Set	
	
OEM NO	SJ4105 - VLV 3092269
VEHICLE	VOLVO FH12/FH16 - VOLVO FM9/FM10/ FM12 / FMX - VOLVO BUS B7L / B12B / B12M

NR	GTSA KOD	DESCRIPTION	QTY
1	2.851	Caliper Cover Gasket	1
2	265.11	Caliper Rubber Cap	1
3	265.10	Caliper Actuator Seal	1
4	265.13	Caliper Manual Adjusting Shaft Seal	1

GTM2.848 Caliper Tappet Boot Set			
			
OEM NO	MN 35.40311.2182 - MRT MCK1139 - MCK1288 - 68324854PK10		
NR	GTSA KOD	DESCRIPTION	QTY
1	265.01	Caliper Tappet Boot	2

GTM2.849 Caliper Pin Boot Set			
			
NR	GTSA KOD	DESCRIPTION	QTY
1	265.03	Caliper Pin Boot	2

281.06 Caliper Lever Bearing	
	
OEM NO	
VEHICLE	

265.12 Caliper Rubber Cap	
	
OEM NO	
VEHICLE	

GTM2.8044 Caliper Small Gear Mechanism - L



OEM NO 68322562 - VLV 3092281

VEHICLE

GTM2.8048 Brake Pad Retainer Repair Kit



OEM NO MCK1264 - VLV 3092276 - 3092277

VEHICLE

GTM2.8093 Caliper Mechanism Anti Rotation Plate - 98 mm



OEM NO 68322485

VEHICLE VOLVO FH12/FH16 - VOLVO FM9 /FM12/FMX - VOLVO FL6

GTM2.842 Caliper Mechanism Anti Rotation Plate - 119,50 mm



OEM NO 68322900

VEHICLE VOLVO FH12/FH16 - VOLVO FM9 /FM10/FM12/FMX - VOLVO BUS B7L/ B12B/B12M

GTM2.8043 Caliper Small Gear Mechanism - R



OEM NO 68322563 - VLV 3092280

VEHICLE

281.02 Caliper Lever Bearing



OEM NO

VEHICLE

MRT DUCO

SM2029

Caliper Complete Repair Kit



VEHICLE VOLVO FL6 L MIDLUM

NR	GTSA KOD	DESCRIPTION	QTY	NR	GTSA KOD	DESCRIPTION	QTY
1	GTM2.881	Caliper Pin Repair Kit	1	4	GTM2.8107	Caliper Lever Set	1
2	GTM2.8106	Caliper Adjusting Mechanism Shaft Set	1	5	265.12	Caliper Rubber Cap	1
3	GTM2.856	Caliper Adjusting Mechanism Set - R	1	6	GTM2.8010	Caliper Visual Indicator	1

SM2030

Caliper Complete Repair Kit - L



VEHICLE VOLVO FH12 - VOLVO FM9/FM12 - VOLVO FL6

NR	GTSA KOD	DESCRIPTION	QTY	NR	GTSA KOD	DESCRIPTION	QTY
1	GTM2.881	Caliper Pin Repair Kit	1	7	GTM2.8065	Caliper Lever Set - L	1
2	GTM2.855	Caliper Adjusting Mechanism Set - L	1	8	GTM2.8010	Caliper Visual Indicator	1
3	GTM2.846	Caliper Adjusting Mechanism Shaft Set - L	1	9	265.11	Caliper Rubber Cap	1
4	GTM2.8093	Caliper Mechanism Anti Rotation Plate - 98 mm	1	10	2.885	Caliper Cover Gasket	1
5	GTM2.8092	Caliper Intermediate Gear & Spring Set	1	11	265.13	Caliper Manual Adjusting Shaft Seal	1
6	GTM2.8044	Caliper Small Gear Mechanism - L	1				

SM2031

Caliper Complete Repair Kit - R



VEHICLE VOLVO FH12 - VOLVO FM9/FM12 - VOLVO FL6

NR	GTSA KOD	DESCRIPTION	QTY	NR	GTSA KOD	DESCRIPTION	QTY
1	GTM2.881	Caliper Pin Repair Kit	1	7	GTM2.8064	Caliper Lever Set - R	1
2	GTM2.856	Caliper Adjusting Mechanism Set - R	1	8	GTM2.8010	Caliper Visual Indicator	1
3	GTM2.845	Caliper Adjusting Mechanism Shaft Set - R	1	9	265.11	Caliper Rubber Cap	1
4	GTM2.8093	Caliper Mechanism Anti Rotation Plate - 98 mm	1	10	2.885	Caliper Cover Gasket	1
5	GTM2.8092	Caliper Intermediate Gear & Spring Set	1	11	265.13	Caliper Manual Adjusting Shaft Seal	1
6	GTM2.8043	Caliper Small Gear Mechanism - R	1				

SM2034

Caliper Complete Repair Kit



VEHICLE VOLVO FH12/FH16 - VOLVO FM9/FM10/FM12 - VOLVO FL6/FM7 - VOLVO BUS B12B/B12M

NR	GTSA KOD	DESCRIPTION	QTY	NR	GTSA KOD	DESCRIPTION	QTY
1	GTM2.860	Caliper Pin Repair Kit	1	7	GTM2.8044	Caliper Small Gear Mechanism - L	1
2	GTM2.856	Caliper Adjusting Mechanism Set - R	1	8	GTM2.8042	Caliper Lever Set	1
3	2.843	Caliper Adjusting Mechanism Shaft Set - R / L	1	9	GTM2.8010	Caliper Visual Indicator	1
4	265.10	Caliper Actuator Seal	1	10	265.12	Caliper Rubber Cap	1
5	GTM2.842	Caliper Mechanism Anti Rotation Plate	1	11	2.884	Caliper Cover Gasket	1
6	GTM2.841	Caliper Intermediate Gear & Spring Set	1				

MRT LISA

GTM2.8050

Caliper Pin Repair Kit



OEM NO SJ4052 - DF 1522192 - RNL1 5001 845 385 - NSSN 69029720

VEHICLE RENAULT PREMIUM/MIDLUM - NISSAN M140 ECOT

NR	GTSA KOD	DESCRIPTION	QTY
1	251.22	Caliper Pin - Ø30x115 mm	1
2	251.23	Caliper Pin - Ø30x75 mm	1
3	255.24	Caliper Pin Bolt - M18x1,50x135 mm	1
4	255.25	Caliper Pin Bolt - M18x1,50x95 mm	1
5	261.15	Caliper Pin Fiber Bush - Ø34xØ30x26 mm	2
6	261.16	Caliper Pin Oval Bush - Ø34xØ31-30x26 mm	1
7	275.11	Caliper Pin Boot Ring - Ø42xØ32x12 mm	2
8	271.08	Caliper Pin Cap - Ø42x45 mm	1
9	271.07	Caliper Pin Cap - Ø37x11 mm	1
10	265.27	Caliper Pin Boot	2

GTM2.863

Caliper Pin Repair Kit



OEM NO MRT SJ4076 - MCK1104 - DF 1522184 - VLV 3097542

VEHICLE RENAULT PREMIUM/TR/PR - RENAULT AE/AE MAGNUM - RENAULT MAGNUM E-TECH - VOLVO BUS B7L/B7R - VOLVO BUS B10B/B10L/B12B - RENAULT BUS AGORA

NR	GTSA KOD	DESCRIPTION	QTY
1	251.14	Caliper Pin - Ø35x132 mm	1
2	251.13	Caliper Pin - Ø35x79 mm	1
3	255.01	Caliper Pin Bolt - M20x1,50x150 mm	1
4	255.02	Caliper Pin Bolt - M20x1,50x100 mm	1
5	261.07	Caliper Pin Oval Bush - Ø39xØ36-35x47 mm	1
6	261.02	Caliper Pin Bush - Ø39xØ35x30 mm	2
7	261.08	Caliper Pin Bush - Ø41xØ35x30 mm	2
8	275.08	Caliper Pin Boot Ring - Ø47xØ37x12 mm	2
9	271.03	Caliper Pin Cap - Ø45x17 mm	2
10	265.03	Caliper Pin Boot	2

GTM2.889

Caliper Pin Bolt Repair Kit



OEM NO SJ4021 - VLV 8550881 - DNNS 65537710

VEHICLE

NR	GTSA KOD	DESCRIPTION	QTY
1	255.01	Caliper Pin Bolt - M20x1,50x150 mm	1
2	255.02	Caliper Pin Bolt - M20x1,50x100 mm	1
3	271.03	Caliper Pin Cap - Ø45x17 mm	2

GTM2.891 Caliper Boot & Seal Set

OEM NO SJ4078 - SJ4032 - VLV 3097526 - 3098113 - 8550895 -

VEHICLE

NR	GTSA KOD	DESCRIPTION	QTY
1	265.14	Caliper Cover Gasket	1
2	265.17	Caliper Adjusting Boot	1
3	291.32	Caliper Adjusting O-ring	1
4	265.29	Caliper Spline Shaft Bevel Seal - Ø57xØ40x6 mm	1
5	265.31	Caliper Spline Shaft Seal - Ø52xØ39x5,50 mm	1
6	265.30	Caliper Spline Shaft Shield - Ø62xØ42x6 mm	1
7	265.18	Caliper Tappet Boot	1
8	265.03	Caliper Pin Boot	2
9	265.27	Caliper Pin Boot	2

GTM2.890 Caliper Boot & Seal Set

OEM NO SJ4061 - NSSN 69029770

VEHICLE

NR	GTSA KOD	DESCRIPTION	QTY
1	265.14	Caliper Cover Gasket	1
2	265.17	Caliper Adjusting Boot	1
3	291.32	Caliper Adjusting O-ring	1
4	265.29	Caliper Spline Shaft Bevel Seal - Ø57xØ40x6 mm	1
5	265.31	Caliper Spline Shaft Seal - Ø52xØ39x5,50 mm	1
6	265.30	Caliper Spline Shaft Shield - Ø62xØ42x6 mm	1
7	265.18	Caliper Tappet Boot	1
8	265.27	Caliper Pin Boot	2

GTM2.892 Caliper Bearing Set

OEM NO SJ4031 - VLV 8550893 - NSSN 69029760 - DNNS 6553778

VEHICLE

NR	GTSA KOD	DESCRIPTION	QTY
1	281.11	Caliper Spline Shaft Needle Bearing - Ø52xØ46x16 mm	1
2	281.10	Caliper Spline Shaft Thrust Bearing - Ø72,50xØ46x8,50 mm	1
3	291.33	Caliper Spline Shaft Thrust Washer - Ø73xØ47 mm	1
4	261.21	Caliper Spline Shaft Bush - Ø44xØ40x15 mm	1
5	261.20	Caliper Spline Shaft Ring - Ø44x13 mm	1

MRT LISA

GTM2.8012 Caliper Spline Shaft Mechanism Set - L



OEM NO MCK1021 - MCK1151 - VLV 85104827 - NSSN 69029750 - DNNS 6553776

VEHICLE

NR	GTSA KOD	DESCRIPTION	QTY
1	291.35	Caliper Spline Shaft - L	1
2	291.37	Caliper Spline Shaft Bearing House - L	1
3	291.39	Caliper Spline Shaft Ball Bearing - Ø22 mm	3
4	291.38	Caliper Spline Shaft Anti Rotation Pin	1

GTM2.8011 Caliper Spline Shaft Mechanism Set - R



OEM NO MCK1022 - MCK1152 - VLV 85104828 - NSSN 69030040 - DNNS 6553784

VEHICLE

NR	GTSA KOD	DESCRIPTION	QTY
1	291.34	Caliper Spline Shaft - R	1
2	291.36	Caliper Spline Shaft Bearing House - R	1
3	291.39	Caliper Spline Shaft Ball Bearing - Ø22 mm	3
4	291.38	Caliper Spline Shaft Anti Rotation Pin	1

GTM2.8024 Caliper Brake Lining Plate



OEM NO MRT SJ4117 - 68321441 - VLV 3092765 - NSSN 69029810 - DNNS 65537714

VEHICLE

GTM2.8109 Caliper Brake Lining Plate



OEM NO

VEHICLE

GTM2.815

Caliper Adjusting Gear - L



OEM NO SJ4073 - VLV 3098110 - DNNS 65656410 - RVI 5001845386

VEHICLE

GTM2.813

Caliper Adjusting Mechanism - L



OEM NO SJ4113 - VLV 3092763 - NSSN 69029730 - DNNS CASSJ4113

VEHICLE

GTM2.814

Caliper Adjusting Gear - R



OEM NO SJ4074 - VLV 3098111 - DNNS 6565652 - RNL 5001845387

VEHICLE

GTM2.812

Caliper Adjusting Mechanism - R



OEM NO SJ4114 - VLV 3092764 - RNL 5001856320 - NSSN 69030020

VEHICLE

265.27

Caliper Pin Boot



OEM NO SJ4053

VEHICLE

GTM2.8098

Caliper Lever



OEM NO 68915080 - 68915081 - DNNS 6464646 - 6565645

VEHICLE

MRT LISA

SM2035

Caliper Complete Repair Kit - L



VEHICLE RENAULT MIDLINER/MIDLUM - NISSAN M140 ECOT

NR	GTSA KOD	DESCRIPTION	QTY	NR	GTSA KOD	DESCRIPTION	QTY
1	GTM2.8050	Caliper Pin Repair Kit	1	8	265.30	Caliper Spline Shaft Shield - Ø62xØ42x6 mm	1
2	GTM2.8012	Caliper Spline Shaft Mechanism Set - L	1	9	291.32	Caliper Adjusting O-ring	1
3	GTM2.813	Caliper Adjusting Mechanism - L	1	10	265.17	Caliper Adjusting Boot	1
4	GTM2.815	Caliper Adjusting Gear - L	1	11	265.18	Caliper Tappet Boot	1
5	GTM2.892	Caliper Bearing Set	1	12	265.14	Caliper Cover Gasket	1
6	265.29	Caliper Spline Shaft Bevel Seal - Ø57xØ40x6 mm	1	13	GTM2.8098	Caliper Lever	1
7	265.31	Caliper Spline Shaft Seal - Ø52xØ39x5,50 mm	1	14	GTM2.8109	Caliper Brake Lining Plate	1

SM2036

Caliper Complete Repair Kit - R



VEHICLE RENAULT MIDLINER/MIDLUM - NISSAN M140 ECOT

NR	GTSA KOD	DESCRIPTION	QTY	NR	GTSA KOD	DESCRIPTION	QTY
1	GTM2.8050	Caliper Pin Repair Kit	1	8	265.30	Caliper Spline Shaft Shield - Ø62xØ42x6 mm	1
2	GTM2.8011	Caliper Spline Shaft Mechanism Set - R	1	9	291.32	Caliper Adjusting O-ring	1
3	GTM2.812	Caliper Adjusting Mechanism - R	1	10	265.17	Caliper Adjusting Boot	1
4	GTM2.814	Caliper Adjusting Gear - R	1	11	265.18	Caliper Tappet Boot	1
5	GTM2.892	Caliper Bearing Set	1	12	265.14	Caliper Cover Gasket	1
6	265.29	Caliper Spline Shaft Bevel Seal - Ø57xØ40x6 mm	1	13	GTM2.8098	Caliper Lever	1
7	265.31	Caliper Spline Shaft Seal - Ø52xØ39x5,50 mm	1	14	GTM2.8109	Caliper Brake Lining Plate	1

SM2006

Caliper Complete Repair Kit - L



VEHICLE

RENAULT PREMIUM/TR/PR - RENAULT AE/AE MAGNUM - RENAULT MAGNUM E-TECH - VOLVO BUS B7L/B7R - VOLVO BUS B10B/B10L/B12B - RENAULT BUS AGORA

NR	GTSA KOD	DESCRIPTION	QTY	NR	GTSA KOD	DESCRIPTION	QTY
1	GTM2.863	Caliper Pin Repair Kit	1	8	265.30	Caliper Spline Shaft Shield - Ø62xØ42x6 mm	1
2	GTM2.8012	Caliper Spline Shaft Mechanism Set - L	1	9	291.32	Caliper Adjusting O-ring	1
3	GTM2.813	Caliper Adjusting Mechanism - L	1	10	265.17	Caliper Adjusting Boot	1
4	GTM2.815	Caliper Adjusting Gear - L	1	11	265.18	Caliper Tappet Boot	1
5	GTM2.892	Caliper Bearing Set	1	12	265.14	Caliper Cover Gasket	1
6	265.29	Caliper Spline Shaft Bevel Seal - Ø57xØ40x6 mm	1	13	GTM2.8098	Caliper Lever	1
7	265.31	Caliper Spline Shaft Seal - Ø52xØ39x5,50 mm	1	14	GTM2.8024	Caliper Brake Lining Plate	1

SM2007

Caliper Complete Repair Kit - R



VEHICLE

RENAULT MIDLINER/MIDLUM - NISSAN M140 ECOT

NR	GTSA KOD	DESCRIPTION	QTY	NR	GTSA KOD	DESCRIPTION	QTY
1	GTM2.863	Caliper Pin Repair Kit	1	8	265.30	Caliper Spline Shaft Shield - Ø62xØ42x6 mm	1
2	GTM2.8011	Caliper Spline Shaft Mechanism Set - R	1	9	291.32	Caliper Adjusting O-ring	1
3	GTM2.812	Caliper Adjusting Mechanism - R	1	10	265.17	Caliper Adjusting Boot	1
4	GTM2.814	Caliper Adjusting Gear - R	1	11	265.18	Caliper Tappet Boot	1
5	GTM2.892	Caliper Bearing Set	1	12	265.14	Caliper Cover Gasket	1
6	265.29	Caliper Spline Shaft Bevel Seal - Ø57xØ40x6 mm	1	13	GTM2.8098	Caliper Lever	1
7	265.31	Caliper Spline Shaft Seal - Ø52xØ39x5,50 mm	1	14	GTM2.8024	Caliper Brake Lining Plate	1

MRT

D3

GTM2.864 Caliper Pin Repair Kit

OEM NO SJ4011 - MCK1213 - MB 000 420 0276 - MN 81.50802.6008

VEHICLE

NR	GTSA KOD	DESCRIPTION	QTY
1	251.07	Caliper Pin - Ø32x117 mm	1
2	251.06	Caliper Pin - Ø32x74 mm	1
3	255.04	Caliper Pin Bolt - M18x1,50x120 mm	1
4	255.05	Caliper Pin Bolt - M18x1,50x95 mm	1
5	261.22	Caliper Pin Oval Bush - Ø36xØ33-32x30 mm	1
6	261.10	Caliper Pin Bush - Ø36xØ32x40 mm	2
7	271.06	Caliper Pin Cap - Ø37x12 mm	2
8	291.01	Caliper Pin Dust Cover - Ø61x17 mm	2
9	265.07	Caliper Pin Boot	2

GTM2.865 Caliper Pin Repair Kit

OEM NO SJ4001 - RNL 5001 822 994 - 5001 822 98

VEHICLE

NR	GTSA KOD	DESCRIPTION	QTY
1	251.07	Caliper Pin - Ø32x117 mm	1
2	251.06	Caliper Pin - Ø32x74 mm	1
3	255.04	Caliper Pin Bolt - M18x1,50x120 mm	1
4	255.05	Caliper Pin Bolt - M18x1,50x95 mm	1
5	271.06	Caliper Pin Cap - Ø37x12 mm	2
6	291.01	Caliper Pin Dust Cover - Ø61x17 mm	2
7	265.07	Caliper Pin Boot	2

GTM2.832 Caliper Spline Shaft Cover Set

OEM NO SJ1212 - MB 0004230082 - MN 81.50802.6007 - DF 1522063

VEHICLE

NR	GTSA KOD	DESCRIPTION	QTY
1	2.832	Caliper Spline Shaft Dust Cover	1
2	265.19	Caliper Spline Shaft Boot	1
3	255.23	Caliper Cover Bolt - M8x1,25x40 mm	4
4	255.22	Caliper Cover Bolt - M8x1,25x16 mm	2

GTM2.821 Caliper Manual Adjuster Repair Kit - L



NR	GTSA KOD	DESCRIPTION	QTY
1	291.13	Caliper Manual Adjuster Gear	1
2	291.12	Caliper Manual Adjuster Spring - L	1
3	291.14	Caliper Manual Adjuster Bolt - M10x1,50x50 mm	1
4	291.16	Caliper Manual Adjuster Wavy Washer	1
5	291.15	Caliper Manual Adjuster Rubber Cap	1

OEM NO

VEHICLE

GTM2.820 Caliper Manual Adjuster Repair Kit - R



NR	GTSA KOD	DESCRIPTION	QTY
1	291.13	Caliper Manual Adjuster Gear	1
2	291.11	Caliper Manual Adjuster Spring - R	1
3	291.14	Caliper Manual Adjuster Bolt - M10x1,50x50 mm	1
4	291.16	Caliper Manual Adjuster Wavy Washer	1
5	291.15	Caliper Manual Adjuster Rubber Cap	1

OEM NO

VEHICLE

GTM2.818-1 Caliper Mechanism Clutch System (With Bush) - R



NR	GTSA KOD	DESCRIPTION	QTY
1	291.08	Caliper Mechanism Spring Case	1
2	291.06	Caliper Mechanism Spring - R	1
3	291.10	Caliper Mechanism Washer	4
4	291.09	Caliper Mechanism Washer	3
5	261.17	Caliper Spline Shaft Bush - Ø55xØ50x20 mm	1

OEM NO

VEHICLE

MRT

D3

GTM2.819 Caliper Mechanism Clutch System - L



OEM NO

VEHICLE

NR	GTSA KOD	DESCRIPTION	QTY
1	291.08	Caliper Mechanism Spring Case	1
2	291.07	Caliper Mechanism Spring - L	1
3	291.10	Caliper Mechanism Washer	4
4	291.09	Caliper Mechanism Washer	3

GTM2.819-1 Caliper Mechanism Clutch System (With Bush) - L



OEM NO

VEHICLE

NR	GTSA KOD	DESCRIPTION	QTY
1	291.08	Caliper Mechanism Spring Case	1
2	291.07	Caliper Mechanism Spring - L	1
3	291.10	Caliper Mechanism Washer	4
4	291.09	Caliper Mechanism Washer	3
5	261.17	Caliper Spline Shaft Bush - Ø55xØ50x20 mm	1

GTM2.818 Caliper Mechanism Clutch System - R



OEM NO

VEHICLE

NR	GTSA KOD	DESCRIPTION	QTY
1	291.08	Caliper Mechanism Spring Case	1
2	291.06	Caliper Mechanism Spring - R	1
3	291.10	Caliper Mechanism Washer	4
4	291.09	Caliper Mechanism Washer	3

GTM2.816 Caliper Adjusting Gear - R	
	
OEM NO	
VEHICLE	

GTM2.817 Caliper Adjusting Gear - L	
	
OEM NO	
VEHICLE	

GTM2.831 Caliper Spline Shaft Wavy Washer	
	
OEM NO	68320133
VEHICLE	

GTM2.829 Caliper Spline Shaft Ball Bearing	
	
OEM NO	
VEHICLE	

GTM2.830 Caliper Spline Shaft Thrust Bearing	
	
OEM NO	
VEHICLE	

GTM2.8066 Caliper Spline Shaft Seal Set	
	
OEM NO	
VEHICLE	

MRT

D3

GTM2.8068 Caliper Spline Shaft Seal & Circlip Set



NR	GTSA KOD	DESCRIPTION	QTY
1	265.32	Caliper Spline Shaft Seal	5
2	291.47	Caliper Spline Shaft Circlip - Ø59x1,50 mm	5

GTM2.8067 Caliper Spline Shaft Circlip Set

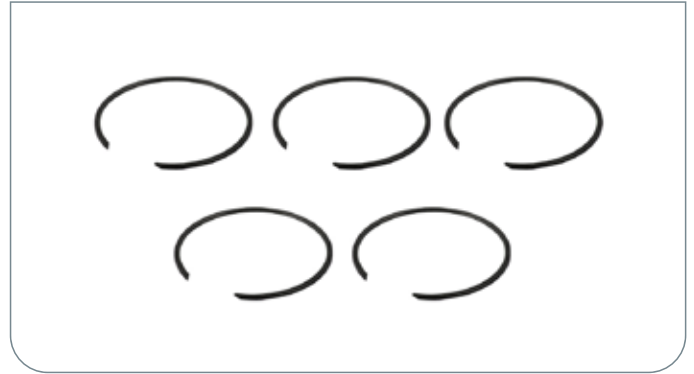

NR	GTSA KOD	DESCRIPTION	QTY
1	291.47	Caliper Spline Shaft Circlip - Ø59x1,50 mm	5

291.48 Caliper Spline Shaft Calibration Ring



OEM NO	
VEHICLE	

291.31 Caliper Manual Adjuster Spring Case



OEM NO	
VEHICLE	

291.40 Caliper Adjusting Gear Spring



OEM NO	
VEHICLE	

GTM2.8115 Brake Pad Retainer Repair Kit



OEM NO	68320550 - 68323027 - MB 356 421 0046 - MN 81.50822.0001 - 81.50822.0010
VEHICLE	

GTM2.897 Caliper Spline Shaft / Front - L (48 Teeth)



OEM NO

VEHICLE

GTM2.896 Caliper Spline Shaft / Front - R (48 Teeth)



OEM NO

VEHICLE

GTM2.823 Caliper Spline Shaft / Front - L (26 Teeth)



OEM NO

VEHICLE

GTM2.822 Caliper Spline Shaft / Front - R (26 Teeth)



OEM NO

VEHICLE

GTM2.825 Caliper Spline Shaft / Rear - L (26 Teeth)



OEM NO

VEHICLE

GTM2.824 Caliper Spline Shaft / Rear - R (26 Teeth)



OEM NO

VEHICLE

MRT

D3

2.823-1

Caliper Spline Shaft Bearing House - L



OEM NO

VEHICLE

GTM2.8097

Caliper Lever - (48 Teeth)



OEM NO

68321502 - MN 81.50812.0009 - VLV 10552713

VEHICLE

GTM2.828

Caliper Brake Lining Plate



OEM NO

68320912 - 68321272 - MB 000 423 0062 - MN 81.50822.0003

VEHICLE

GTM2.857

Caliper Lever - (26 Teeth)



OEM NO

31921070 - 68321507 - 68321508 - MN 81.50812.001 - VLV 2111686

VEHICLE

GTM2.8004 Caliper Complete Repair Kit / Front - L (48 Teeth)



VEHICLE MAN F2000/F90 - RENAULT PREMIUM/MAGNUM

NR	GTSA KOD	DESCRIPTION	QTY	NR	GTSA KOD	DESCRIPTION	QTY
1	GTM2.832	Caliper Spline Shaft Cover Set	1	6	261.17	Caliper Spline Shaft Bush - Ø55xØ50x20 mm	1
2	GTM2.897	Caliper Spline Shaft / Front - L (48 Teeth)	1	7	265.24	Caliper Spline Shaft Cover	1
3	GTM2.817	Caliper Adjusting Gear - L	1	8	GTM2.829	Caliper Spline Shaft Ball Bearing	1
4	GTM2.819	Caliper Mechanism Clutch System - L	1	9	GTM2.830	Caliper Spline Shaft Thrust Bearing	1
5	GTM2.820	Caliper Manual Adjuster Repair Kit - R	1	10	GTM2.831	Caliper Spline Shaft Wavy Washer	1

GTM2.8003 Caliper Complete Repair Kit / Front - R (48 Teeth)



VEHICLE MAN F2000/F90 - RENAULT PREMIUM/MAGNUM

NR	GTSA KOD	DESCRIPTION	QTY	NR	GTSA KOD	DESCRIPTION	QTY
1	GTM2.832	Caliper Spline Shaft Cover Set	1	6	261.17	Caliper Spline Shaft Bush - Ø55xØ50x20 mm	1
2	GTM2.896	Caliper Spline Shaft / Front - R (48 Teeth)	1	7	265.24	Caliper Spline Shaft Cover	1
3	GTM2.816	Caliper Adjusting Gear - R	1	8	GTM2.829	Caliper Spline Shaft Ball Bearing	1
4	GTM2.818	Caliper Mechanism Clutch System - R	1	9	GTM2.830	Caliper Spline Shaft Thrust Bearing	1
5	GTM2.821	Caliper Manual Adjuster Repair Kit - L	1	10	GTM2.831	Caliper Spline Shaft Wavy Washer	1

MRT

D3

GTM2.8002 Caliper Complete Repair Kit / Front - L (26 Teeth)



VEHICLE MB BUS O350/0403/0404 - EVOBUS INTEGRO - SETRA S315 GT

NR	GTSA KOD	DESCRIPTION	QTY	NR	GTSA KOD	DESCRIPTION	QTY
1	GTM2.832	Caliper Spline Shaft Cover Set	1	6	261.17	Caliper Spline Shaft Bush - Ø55xØ50x20 mm	1
2	GTM2.823	Caliper Spline Shaft / Front - L (26 Teeth)	1	7	265.24	Caliper Spline Shaft Cover	1
3	GTM2.817	Caliper Adjusting Gear - L	1	8	GTM2.829	Caliper Spline Shaft Ball Bearing	1
4	GTM2.819	Caliper Mechanism Clutch System - L	1	9	GTM2.830	Caliper Spline Shaft Thrust Bearing	1
5	GTM2.820	Caliper Manual Adjuster Repair Kit - R	1	10	GTM2.831	Caliper Spline Shaft Wavy Washer	1

GTM2.8001 Caliper Complete Repair Kit / Front - R (26 Teeth)



VEHICLE MAN F2000/F90 - RENAULT PREMIUM/MAGNUM

NR	GTSA KOD	DESCRIPTION	QTY	NR	GTSA KOD	DESCRIPTION	QTY
1	GTM2.832	Caliper Spline Shaft Cover Set	1	6	261.17	Caliper Spline Shaft Bush - Ø55xØ50x20 mm	1
2	GTM2.822	Caliper Spline Shaft / Front - R (26 Teeth)	1	7	265.24	Caliper Spline Shaft Cover	1
3	GTM2.816	Caliper Adjusting Gear - R	1	8	GTM2.829	Caliper Spline Shaft Ball Bearing	1
4	GTM2.818	Caliper Mechanism Clutch System - R	1	9	GTM2.830	Caliper Spline Shaft Thrust Bearing	1
5	GTM2.821	Caliper Manual Adjuster Repair Kit - L	1	10	GTM2.831	Caliper Spline Shaft Wavy Washer	1

GTM2.8006 Caliper Complete Repair Kit / Rear - L (26 Teeth)



VEHICLE MB BUS 0350/0403/0404

NR	GTSA KOD	DESCRIPTION	QTY	NR	GTSA KOD	DESCRIPTION	QTY
1	GTM2.832	Caliper Spline Shaft Cover Set	1	6	261.17	Caliper Spline Shaft Bush - Ø55xØ50x20 mm	1
2	GTM2.825	Caliper Spline Shaft / Rear - L (26 Teeth)	1	7	265.24	Caliper Spline Shaft Cover	1
3	GTM2.817	Caliper Adjusting Gear - L	1	8	GTM2.829	Caliper Spline Shaft Ball Bearing	1
4	GTM2.819	Caliper Mechanism Clutch System - L	1	9	GTM2.830	Caliper Spline Shaft Thrust Bearing	1
5	GTM2.820	Caliper Manual Adjuster Repair Kit - R	1	10	GTM2.831	Caliper Spline Shaft Wavy Washer	1

GTM2.8005 Caliper Complete Repair Kit / Rear - R (26 Teeth)



VEHICLE MAN F2000/F90 - RENAULT PREMIUM/MAGNUM

NR	GTSA KOD	DESCRIPTION	QTY	NR	GTSA KOD	DESCRIPTION	QTY
1	GTM2.832	Caliper Spline Shaft Cover Set	1	6	261.17	Caliper Spline Shaft Bush - Ø55xØ50x20 mm	1
2	GTM2.824	Caliper Spline Shaft / Rear - R (26 Teeth)	1	7	265.24	Caliper Spline Shaft Cover	1
3	GTM2.816	Caliper Adjusting Gear - R	1	8	GTM2.829	Caliper Spline Shaft Ball Bearing	1
4	GTM2.818	Caliper Mechanism Clutch System - R	1	9	GTM2.830	Caliper Spline Shaft Thrust Bearing	1
5	GTM2.821	Caliper Manual Adjuster Repair Kit - L	1	10	GTM2.831	Caliper Spline Shaft Wavy Washer	1

MRT

D3

SM2025

Caliper Complete Repair Kit / Front - L (48 Teeth)



VEHICLE MAN F2000/F90 - RENAULT PREMIUM/MAGNUM

NR	GTSA KOD	DESCRIPTION	QTY	NR	GTSA KOD	DESCRIPTION	QTY
1	GTM2.864	Caliper Pin Repair Kit	1	10	GTM2.830	Caliper Spline Shaft Thrust Bearing	1
2	GTM2.832	Caliper Spline Shaft Cover Set	1	11	GTM2.831	Caliper Spline Shaft Wavy Washer	1
3	GTM2.897	Caliper Spline Shaft / Front - L (48 Teeth)	1	12	261.17	Caliper Spline Shaft Bush - Ø55xØ50x20 mm	1
4	GTM2.817	Caliper Adjusting Gear - L	1	13	265.24	Caliper Spline Shaft Cover	1
5	291.40	Caliper Adjusting Gear Spring	1	14	265.32	Caliper Spline Shaft Seal	1
6	GTM2.819	Caliper Mechanism Clutch System - L	1	15	291.47	Caliper Spline Shaft Circlip - Ø59x1,50 mm	1
7	GTM2.820	Caliper Manual Adjuster Repair Kit - R	1	16	291.48	Caliper Spline Shaft Calibration Ring	1
8	291.31	Caliper Manual Adjuster Spring Case	1	17	GTM2.828	Caliper Brake Lining Plate	1
9	GTM2.829	Caliper Spline Shaft Ball Bearing	1	18	GTM2.8097	Caliper Lever - (48 Teeth)	1

SM2026

Caliper Complete Repair Kit / Front - R (48 Teeth)



VEHICLE MAN F2000/F90 - RENAULT PREMIUM/MAGNUM

NR	GTSA KOD	DESCRIPTION	QTY	NR	GTSA KOD	DESCRIPTION	QTY
1	GTM2.864	Caliper Pin Repair Kit	1	10	GTM2.830	Caliper Spline Shaft Thrust Bearing	1
2	GTM2.832	Caliper Spline Shaft Cover Set	1	11	GTM2.831	Caliper Spline Shaft Wavy Washer	1
3	GTM2.896	Caliper Spline Shaft / Front - R (48 Teeth)	1	12	261.17	Caliper Spline Shaft Bush - Ø55xØ50x20 mm	1
4	GTM2.816	Caliper Adjusting Gear - R	1	13	265.24	Caliper Spline Shaft Cover	1
5	291.40	Caliper Adjusting Gear Spring	1	14	265.32	Caliper Spline Shaft Seal	1
6	GTM2.818	Caliper Mechanism Clutch System - R	1	15	291.47	Caliper Spline Shaft Circlip - Ø59x1,50 mm	1
7	GTM2.821	Caliper Manual Adjuster Repair Kit - L	1	16	291.48	Caliper Spline Shaft Calibration Ring	1
8	291.31	Caliper Manual Adjuster Spring Case	1	17	GTM2.828	Caliper Brake Lining Plate	1
9	GTM2.829	Caliper Spline Shaft Ball Bearing	1	18	GTM2.8097	Caliper Lever - (48 Teeth)	1

SM2023

Caliper Complete Repair Kit / Front - L (26 Teeth)



VEHICLE MB BUS 0350/0403/0404 - EVOBUS INTEGRO - SETRA S315 GT

NR	GTSA KOD	DESCRIPTION	QTY	NR	GTSA KOD	DESCRIPTION	QTY
1	GTM2.864	Caliper Pin Repair Kit	1	10	GTM2.830	Caliper Spline Shaft Thrust Bearing	1
2	GTM2.832	Caliper Spline Shaft Cover Set	1	11	GTM2.831	Caliper Spline Shaft Wavy Washer	1
3	GTM2.823	Caliper Spline Shaft / Front - L (26 Teeth)	1	12	261.17	Caliper Spline Shaft Bush - Ø55xØ50x20 mm	1
4	GTM2.817	Caliper Adjusting Gear - L	1	13	265.24	Caliper Spline Shaft Cover	1
5	291.40	Caliper Adjusting Gear Spring	1	14	265.32	Caliper Spline Shaft Seal	1
6	GTM2.819	Caliper Mechanism Clutch System - L	1	15	291.47	Caliper Spline Shaft Circlip - Ø59x1,50 mm	1
7	GTM2.820	Caliper Manual Adjuster Repair Kit - R	1	16	291.48	Caliper Spline Shaft Calibration Ring	1
8	291.31	Caliper Manual Adjuster Spring Case	1	17	GTM2.828	Caliper Brake Lining Plate	1
9	GTM2.829	Caliper Spline Shaft Ball Bearing	1	18	GTM2.857	Caliper Lever - (26 Teeth)	1

SM2024

Caliper Complete Repair Kit / Front - R (26 Teeth)



VEHICLE MB BUS 0350/0403/0404 - EVOBUS INTEGRO - SETRA S315 GT

NR	GTSA KOD	DESCRIPTION	QTY	NR	GTSA KOD	DESCRIPTION	QTY
1	GTM2.864	Caliper Pin Repair Kit	1	10	GTM2.831	Caliper Spline Shaft Wavy Washer	1
2	GTM2.832	Caliper Spline Shaft Cover Set	1	11	261.17	Caliper Spline Shaft Bush - Ø55xØ50x20 mm	1
3	GTM2.822	Caliper Spline Shaft / Front - R (26 Teeth)	1	12	265.24	Caliper Spline Shaft Cover	1
4	GTM2.816	Caliper Adjusting Gear - R	1	13	265.32	Caliper Spline Shaft Seal	1
5	GTM2.818	Caliper Mechanism Clutch System - R	1	14	291.47	Caliper Spline Shaft Circlip - Ø59x1,50 mm	1
6	GTM2.821	Caliper Manual Adjuster Repair Kit - L	1	15	291.48	Caliper Spline Shaft Calibration Ring	1
7	291.31	Caliper Manual Adjuster Spring Case	1	16	GTM2.828	Caliper Brake Lining Plate	1
8	GTM2.829	Caliper Spline Shaft Ball Bearing	1	17	GTM2.857	Caliper Lever - (26 Teeth)	1
9	GTM2.830	Caliper Spline Shaft Thrust Bearing	1				

MRT

D3

SM2027

Caliper Complete Repair Kit / Rear - L (26 Teeth)



VEHICLE MB BUS 0350/0403/0404

NR	GTSA KOD	DESCRIPTION	QTY	NR	GTSA KOD	DESCRIPTION	QTY
1	GTM2.864	Caliper Pin Repair Kit	1	10	GTM2.830	Caliper Spline Shaft Thrust Bearing	1
2	GTM2.832	Caliper Spline Shaft Cover Set	1	11	GTM2.831	Caliper Spline Shaft Wavy Washer	1
3	GTM2.825	Caliper Spline Shaft / Rear - L (26 Teeth)	1	12	261.17	Caliper Spline Shaft Bush - Ø55xØ50x20 mm	1
4	GTM2.817	Caliper Adjusting Gear - L	1	13	265.24	Caliper Spline Shaft Cover	1
5	291.40	Caliper Adjusting Gear Spring	1	14	265.32	Caliper Spline Shaft Seal	1
6	GTM2.819	Caliper Mechanism Clutch System - L	1	15	291.47	Caliper Spline Shaft Circlip - Ø59x1,50 mm	1
7	GTM2.820	Caliper Manual Adjuster Repair Kit - R	1	16	291.48	Caliper Spline Shaft Calibration Ring	1
8	291.31	Caliper Manual Adjuster Spring Case	1	17	GTM2.828	Caliper Brake Lining Plate	1
9	GTM2.829	Caliper Spline Shaft Ball Bearing	1	18	GTM2.857	Caliper Lever - (26 Teeth)	1

SM2028

Caliper Complete Repair Kit / Rear - R (26Teeth)



VEHICLE MB BUS 0350/0403/0404

NR	GTSA KOD	DESCRIPTION	QTY	NR	GTSA KOD	DESCRIPTION	QTY
1	GTM2.864	Caliper Pin Repair Kit	1	10	GTM2.830	Caliper Spline Shaft Thrust Bearing	1
2	GTM2.832	Caliper Spline Shaft Cover Set	1	11	GTM2.831	Caliper Spline Shaft Wavy Washer	1
3	GTM2.824	Caliper Spline Shaft / Rear - R (26 Teeth)	1	12	261.17	Caliper Spline Shaft Bush - Ø55xØ50x20 mm	1
4	GTM2.816	Caliper Adjusting Gear - R	1	13	265.24	Caliper Spline Shaft Cover	1
5	291.40	Caliper Adjusting Gear Spring	1	14	265.32	Caliper Spline Shaft Seal	1
6	GTM2.818	Caliper Mechanism Clutch System - R	1	15	291.47	Caliper Spline Shaft Circlip - Ø59x1,50 mm	1
7	GTM2.821	Caliper Manual Adjuster Repair Kit - L	1	16	291.48	Caliper Spline Shaft Calibration Ring	1
8	291.31	Caliper Manual Adjuster Spring Case	1	17	GTM2.828	Caliper Brake Lining Plate	1
9	GTM2.829	Caliper Spline Shaft Ball Bearing	1	18	GTM2.857	Caliper Lever - (26 Teeth)	1



WBC

GTW3.718 Caliper Boot & Pin Repair Kit



OEM NO: WBC 12 999 699 VT - 12 999 702 - DF 1436853 - IVECO 42536957 - OTKR 13C3508276AA

VEHICLE: MAN L2000/M2000-L - DAF LF45 - RENAULT MIDLUM M112 - IVECO EUROARGO - IVECO BUS EUROPOLIS

NR	GTSA KOD	DESCRIPTION	QTY
1	351.01	Caliper Pin - Ø30x91 mm	1
2	351.02	Caliper Pin - Ø30x77 mm	1
3	355.01.01	Caliper Pin Bolt - M16x1,50x90 mm	1
4	155.05.01	Caliper Pin Bolt - M16x1,50x70 mm	1
5	361.01	Caliper Pin Bush - Ø34xØ30x20 mm	3
6	371.01	Caliper Pin Cap - Ø34x17 mm	2
7	365.02	Caliper Tappet Boot	1
8	365.01	Caliper Pin Boot	2
9	365.07	Caliper Head Cap	1

GTW3.7005 Caliper Boot & Pin Repair Kit



OEM NO:

VEHICLE:

NR	GTSA KOD	DESCRIPTION	QTY
1	351.01	Caliper Pin - Ø30x91 mm	1
2	351.02	Caliper Pin - Ø30x77 mm	1
3	355.01.01	Caliper Pin Bolt - M16x1,50x90 mm	1
4	155.05.01	Caliper Pin Bolt - M16x1,50x70 mm	1
5	361.01	Caliper Pin Bush - Ø34xØ30x20 mm	2
6	361.05	Caliper Pin Bush - Ø34xØ30x25 mm	1
7	371.01	Caliper Pin Cap - Ø34x17 mm	1
8	371.04	Caliper Pin Cap - Ø34x38 mm	1
9	365.02	Caliper Tappet Boot	1
10	365.01	Caliper Pin Boot	2
11	365.07	Caliper Head Cap	1

GTW3.720 Caliper Boot & Pin Bolt Repair Kit



OEM NO: WBC 12 999 704 VT - DF 1519363 - RNLT 5001 852 880

VEHICLE:

NR	GTSA KOD	DESCRIPTION	QTY
1	355.01.01	Caliper Pin Bolt - M16x1,50x90 mm	1
2	155.05.01	Caliper Pin Bolt - M16x1,50x70 mm	1
3	361.01	Caliper Pin Bush - Ø34xØ30x20 mm	3
4	371.01	Caliper Pin Cap - Ø34x17 mm	2
5	365.02	Caliper Tappet Boot	1
6	365.02	Caliper Tappet Boot	1
7	365.01	Caliper Pin Boot	2

WBC

PAN 17

GTW3.753 Caliper Boot & Pin Bush Set	
	
OEM NO	
VEHICLE	

NR	GTSA KOD	DESCRIPTION	QTY
1	361.01	Caliper Pin Bush - Ø34xØ30x20 mm	3
2	371.01	Caliper Pin Cap - Ø34x17 mm	2
3	365.02	Caliper Tappet Boot	1
4	365.01	Caliper Pin Boot	2

GTW3.719 Caliper Boot & Bolt Set	
	
OEM NO	WBC 12 999 580 VT - MN 81.50822.6003 - DF 1517407
VEHICLE	

NR	GTSA KOD	DESCRIPTION	QTY
1	GTW3.720	Caliper Boot & Pin Bolt Repair Kit	1
2	GTW3.726-2	Caliper Head Gasket Set	1
3	355.03	Caliper Head Bolt - M10x1,00x40 mm	8

GTW3.740 Caliper Adjusting Mechanism Set	
	
OEM NO	
VEHICLE	

NR	GTSA KOD	DESCRIPTION	QTY
1	391.04	Caliper Adjusting Mechanism Spring - Ø22,30x22,15 mm	1
2	391.12	Caliper Adjusting Mechanism Bevel Washer - Ø45xØ32 mm	1
3	391.10	Caliper Adjusting Mechanism Washer - Ø41,40xØ14,25 mm	1
4	391.11	Caliper Adjusting Mechanism Bottom Washer - Ø49,40xØ35,50 mm	1
5	391.03	Caliper Adjusting Mechanism Locker Ring	1
6	391.09	Caliper Adjusting Mechanism Clips	1

GTW3.737

Caliper Adjusting Mechanism Set



OEM NO

VEHICLE

NR	GTSA KOD	DESCRIPTION	QTY
1	GTW3.740	Caliper Adjusting Mechanism Washer & Spring Set	1
2	368.04	Caliper Adjusting Mechanism Slot - 110 mm	1
3	GTW3.700	Caliper Calibration Bolt - 87 mm - (With Pin)	1
4	391.08-1	Mechanism Torsion Spring Ring - (Thick)	1
5	391.08-2	Mechanism Torsion Spring Ring - (Thin)	1
6	391.02	Mechanism Torsion Spring - Ø42,50x22 mm	1

GTW3.706

Caliper Adjusting Mechanism Set



OEM NO

VEHICLE

NR	GTSA KOD	DESCRIPTION	QTY
1	GTW3.740	Caliper Adjusting Mechanism Washer & Spring Set	1
2	368.04	Caliper Adjusting Mechanism Slot - 110 mm	1
3	391.08-1	Mechanism Torsion Spring Ring - (Thick)	1
4	391.08-2	Mechanism Torsion Spring Ring - (Thin)	1
5	391.02	Mechanism Torsion Spring - Ø42,50x22 mm	1

GTW3.726-1

Caliper Head Gasket & Bolt Set



OEM NO

VEHICLE

NR	GTSA KOD	DESCRIPTION	QTY
1	365.09	Caliper Head Gasket	1
2	365.08	Caliper Head Seal	1
3	365.07	Caliper Head Cap	1
4	355.03	Caliper Head Bolt - M10x1,00x40 mm	8

WBC

PAN 17

GTW3.714

Caliper Head Seal Set- Short



NR	GTSA KOD	DESCRIPTION	QTY
1	365.13	Caliper Head Seal - Short	5

GTW3.731

Caliper Needle Bearing Set



NR	GTSA KOD	DESCRIPTION	QTY
1	381.01	Caliper Needle Bearing	2

GTW3.739

Caliper Pin Cap Set



NR	GTSA KOD	DESCRIPTION	QTY
1	365.02	Caliper Tappet Boot	1
2	365.01	Caliper Pin Boot	2

GTW3.713

Caliper Pin Cap Set



NR	GTSA KOD	DESCRIPTION	QTY
1	371.04	Caliper Pin Cap - Ø34x38 mm	5

GTW3.729

Caliper Complete Mechanism Set - (With Groove)



NR	GTSA KOD	DESCRIPTION	QTY
1	GTW3.702	Caliper Calibration Bolt - 87 mm - (With Groove)	1
2	GTW3.706	Caliper Adjusting Mechanism Set	1
3	GTW3.727	Caliper Shaft Housing Set	1

GTW3.728

Caliper Complete Mechanism Set - (With Pin)



NR	GTSA KOD	DESCRIPTION	QTY
1	GTW3.700	Caliper Calibration Bolt - 87 mm - (With Pin)	1
2	GTW3.706	Caliper Adjusting Mechanism Set	1
3	GTW3.727	Caliper Shaft Housing Set	1

GTW3.726-2 Caliper Head Gasket Set



OEM NO	
VEHICLE	

NR	GTSA KOD	DESCRIPTION	QTY
1	365.09	Caliper Head Gasket	1
2	365.08	Caliper Head Seal	1
3	365.07	Caliper Head Cap	1
4	365.13	Caliper Head Seal - Short	1

GTW3.754 Caliper Tappet Boot & Cap Set



NR	GTSA KOD	DESCRIPTION	QTY
1	365.04	Caliper Tappet Boot	1
2	365.13	Caliper Head Seal - Short	1
3	365.07	Caliper Head Cap	1

GTW3.711 Caliper Lever



OEM NO	
VEHICLE	

GTW3.700 Caliper Calibration Bolt - 87 mm - (With Pin)



OEM NO	
VEHICLE	

GTW3.702 Caliper Calibration Bolt - 87 mm - (With Groove)



OEM NO	
VEHICLE	

WBC

PAN 17

GTW3.758	Brake Pad Retainer Repair Kit
	
OEM NO	
VEHICLE	

GTW3.727	Caliper Shaft Housing Set
	
OEM NO	
VEHICLE	

GTW3.710	Caliper Brake Lining Plate - L - (With Groove)
	
OEM NO	
VEHICLE	

GTW3.708	Caliper Brake Lining Plate - L - (With Pin)
	
OEM NO	
VEHICLE	

GTW3.709	Caliper Brake Lining Plate - R - (With Groove)
	
OEM NO	
VEHICLE	

GTW3.707	Caliper Brake Lining Plate - R - (With Pin)
	
OEM NO	
VEHICLE	

SW3002

Caliper Complete Repair Kit - L - (With Pin)



VEHICLE MAN L2000/M2000-L - DAF LF45 - RENAULT MIDLUM M112 - IVECO EUROCARGO - IVECI BUS EUROPOLIS

NR	GTSA KOD	DESCRIPTION	QTY	NR	GTSA KOD	DESCRIPTION	QTY
1	GTW3.718	Caliper Boot & Pin Repair Kit	1	6	365.09	Caliper Head Gasket	1
2	GTW3.710	Caliper Brake Lining Plate - L - (With Groove)	1	7	365.08	Caliper Head Seal	1
3	GTW3.728	Caliper Complete Mechanism Set - (With Pin)	1	8	365.13	Caliper Head Seal - Short	1
4	GTW3.731	Caliper Needle Bearing Set	1	9	355.03	Caliper Head Bolt - M10x1,00x40 mm	8
5	GTW3.711	Caliper Lever	1				

SW3001

Caliper Complete Repair Kit - R - (With Pin)



VEHICLE MAN L2000/M2000-L - DAF LF45 - RENAULT MIDLUM M112 - IVECO EUROCARGO - IVECI BUS EUROPOLIS

NR	GTSA KOD	DESCRIPTION	QTY	NR	GTSA KOD	DESCRIPTION	QTY
1	GTW3.718	Caliper Boot & Pin Repair Kit	1	6	365.09	Caliper Head Gasket	1
2	GTW3.709	Caliper Brake Lining Plate - R - (With Groove)	1	7	365.08	Caliper Head Seal	1
3	GTW3.728	Caliper Complete Mechanism Set - (With Pin)	1	8	365.13	Caliper Head Seal - Short	1
4	GTW3.731	Caliper Needle Bearing Set	1	9	355.03	Caliper Head Bolt - M10x1,00x40 mm	8
5	GTW3.711	Caliper Lever	1				

WBC

19,5"/ 22,5" Single Piston

GTW3.724 Caliper Boot & Pin Repair Kit

OEM NO: WBC 12 999 738 - DF 1505890 - SF 3 434 3827 01

VEHICLE: SAF SK RLB INTEGRAL - SAF SK NLB INTEGRAL - SAF SKRB INTEGRAL - SAF SKRS/SKRZ

NR	GTSA KOD	DESCRIPTION	QTY
1	351.03	Caliper Pin - Ø38x118 mm	1
2	351.04	Caliper Pin - Ø37.7x76 mm	1
3	355.02	Caliper Pin Bolt - M16x1,50x120 mm	1
4	155.01.01	Caliper Pin Bolt - M16x1,50x80 mm	1
5	361.02	Caliper Pin Bush - Ø42xØ38x30 mm	3
6	371.03	Caliper Pin Cap - Ø42x29 mm	2
7	371.02	Caliper Pin Cap - Ø42x17 mm	2
8	365.04	Caliper Tappet Boot	1
9	365.05	Caliper Tappet Boot - White	2
10	365.03	Caliper Pin Boot	2
11	375.01	Caliper Pin Boot Ring - Ø44,50x1,25 mm	4
12	365.07	Caliper Head Cap	1

GTW3.725-2 Caliper Boot & Pin Repair Kit

OEM NO:

VEHICLE:

NR	GTSA KOD	DESCRIPTION	QTY
1	351.03	Caliper Pin - Ø38x118 mm	1
2	351.04	Caliper Pin - Ø37.7x76 mm	1
3	355.02	Caliper Pin Bolt - M16x1,50x120 mm	1
4	155.01	Caliper Pin Bolt - M16x1,50x80 mm	1
5	361.02	Caliper Pin Bush - Ø42xØ38x30 mm	3
6	371.03	Caliper Pin Cap - Ø42x29 mm	1
7	371.02	Caliper Pin Cap - Ø42x17 mm	1
8	365.04	Caliper Tappet Boot	1
9	365.05	Caliper Tappet Boot - White	2
10	375.01	Caliper Pin Boot Ring - Ø44,50x1,25 mm	2

GTW3.725 Caliper Boot & Pin Repair Kit

OEM NO: WBC 12 999 776 - DF 1628065 - SF 3 434 3828 00 - VLV 85108166 - RNLTL 5001 866 626 - KGL 6500700 - 640 225 921 2

VEHICLE: DAF LF55 - SCHIMITZ TRAILER

NR	GTSA KOD	DESCRIPTION	QTY
1	351.03	Caliper Pin - Ø38x118 mm	1
2	351.04	Caliper Pin - Ø37.7x76 mm	1
3	355.02	Caliper Pin Bolt - M16x1,50x120 mm	1
4	155.01.01	Caliper Pin Bolt - M16x1,50x80 mm	1
5	361.02	Caliper Pin Bush - Ø42xØ38x30 mm	3
6	371.03	Caliper Pin Cap - Ø42x29 mm	1
7	371.02	Caliper Pin Cap - Ø42x17 mm	1
8	365.04	Caliper Tappet Boot	1
9	365.03	Caliper Pin Boot	2
10	375.01	Caliper Pin Boot Ring - Ø44,50x1,25 mm	2
11	365.07	Caliper Head Cap	1

GTW3.725-1 Caliper Boot & Pin Bush Set



OEM NO

VEHICLE

NR	GTSA KOD	DESCRIPTION	QTY
1	361.02	Caliper Pin Bush - Ø42xØ38x30 mm	3
2	371.03	Caliper Pin Cap - Ø42x29 mm	1
3	371.02	Caliper Pin Cap - Ø42x17 mm	1
4	365.04	Caliper Tappet Boot	1
5	365.03	Caliper Pin Boot	2
6	375.01	Caliper Pin Boot Ring - Ø44,50x1,25 mm	2

GTW3.701 Caliper Calibration Bolt - 91 mm



OEM NO

VEHICLE

NR	GTSA KOD	DESCRIPTION	QTY
1	GTW3.740	Caliper Adjusting Mechanism Washer & Spring Set	1
2	368.05	Caliper Adjusting Mechanism Slot - 115 mm	1
3	GTW3.701	Caliper Calibration Bolt - 91 mm	1
4	391.08-1	Mechanism Torsion Spring Ring - (Thick)	1
5	391.08-2	Mechanism Torsion Spring Ring - (Thin)	1
6	391.02	Mechanism Torsion Spring - Ø42,50x22 mm	1

GTW3.705 Caliper Adjusting Mechanism Set (Without Bolt)



OEM NO

VEHICLE

NR	GTSA KOD	DESCRIPTION	QTY
1	GTW3.740	Caliper Adjusting Mechanism Washer & Spring Set	1
2	368.05	Caliper Adjusting Mechanism Slot - 115 mm	1
3	391.08-1	Mechanism Torsion Spring Ring - (Thick)	1
4	391.08-2	Mechanism Torsion Spring Ring - (Thin)	1
5	391.02	Mechanism Torsion Spring - Ø42,50x22 mm	1

WBC

19,5"/ 22,5" Single Piston

GTW3.783 Caliper Tappet Boot & Cap Set	
	
OEM NO	640 175 920 2
VEHICLE	

NR	GTSA KOD	DESCRIPTION	QTY
1	365.04	Caliper Tappet Boot	1
2	365.08	Caliper Head Seal	1
3	365.07	Caliper Head Cap	1

GTW3.726-2 Caliper Head Gasket Set	
	
OEM NO	
VEHICLE	

NR	GTSA KOD	DESCRIPTION	QTY
1	365.09	Caliper Head Gasket	1
2	365.08	Caliper Head Seal	1
3	365.07	Caliper Head Cap	1
4	365.13	Caliper Head Seal - Short	1

GTW3.740 Caliper Adjusting Mechanism Set	
	
OEM NO	
VEHICLE	

NR	GTSA KOD	DESCRIPTION	QTY
1	391.04	Caliper Adjusting Mechanism Spring - Ø22,30x22,15 mm	1
2	391.12	Caliper Adjusting Mechanism Bevel Washer - Ø45xØ32 mm	1
3	391.10	Caliper Adjusting Mechanism Washer - Ø41,40xØ14,25 mm	1
4	391.11	Caliper Adjusting Mechanism Bottom Washer - Ø49,40xØ35,50 mm	1
5	391.03	Caliper Adjusting Mechanism Locker Ring	1
6	391.09	Caliper Adjusting Mechanism Clips	1

GTW3.752

Caliper Boot Set



NR	G TSA KOD	DESCRIPTION	QTY
1	365.04	Caliper Tappet Boot	1
2	365.03	Caliper Pin Boot	2
3	375.01	Caliper Pin Boot Ring - Ø44,50x1,25 mm	2

GTW3.730

Caliper Complete Mechanism Set



NR	G TSA KOD	DESCRIPTION	QTY
1	GTW3.751	Caliper Adjusting Mechanism Set	1
2	GTW3.745	Caliper Shaft Housing Set	1

GTW3.712

Caliper Pin Boot Ring Set

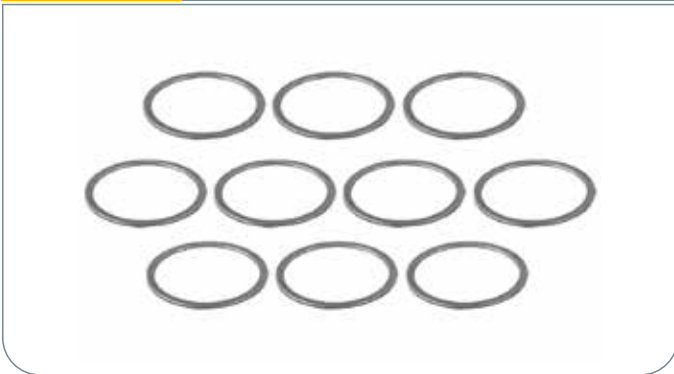

NR	G TSA KOD	DESCRIPTION	QTY
1	375.01	Caliper Pin Boot Ring - Ø44,50x1,25 mm	10

GTW3.731

Caliper Needle Bearing Set



NR	G TSA KOD	DESCRIPTION	QTY
1	381.01	Caliper Needle Bearing	2

GTW3.757

Brake Pad Retainer Repair Kit



OEM NO	
VEHICLE	SAF Axle

GTW3.755

Brake Pad Retainer Repair Kit



OEM NO	
VEHICLE	RENAULT MIDLUM

WBC

19,5"/ 22,5" Single Piston

GTW3.736 Caliper Brake Lining Plate - L	
	
OEM NO	640 195 936 2 - L
VEHICLE	

GTW3.735 Caliper Brake Lining Plate - R	
	
OEM NO	640 195 936 2 - R
VEHICLE	

GTW3.734 Caliper Brake Lining Plate - R	
	
OEM NO	640 225 926 2 - L
VEHICLE	

GTW3.733 Caliper Brake Lining Plate - R	
	
OEM NO	640 225 926 2 - R
VEHICLE	

GTW3.745 Caliper Shaft Housing Set	
	
OEM NO	
VEHICLE	

GTW3.711 Caliper Lever	
	
OEM NO	
VEHICLE	

SW3004

Caliper Complete Repair Kit - L



VEHICLE DAF LF55 - SCHIMITZ TRAILER

NR	GTSA KOD	DESCRIPTION	QTY
1	GTW3.725	Caliper Boot & Pin Repair Kit	1
2	GTW3.736	Caliper Brake Lining Plate - L	1
3	GTW3.730	Caliper Complete Mechanism Set	1
4	GTW3.731	Caliper Needle Bearing Set	1
5	GTW3.711	Caliper Lever	1

NR	GTSA KOD	DESCRIPTION	QTY
6	365.09	Caliper Head Gasket	1
7	365.08	Caliper Head Seal	1
8	365.13	Caliper Head Seal - Short	1
9	355.03	Caliper Head Bolt - M10x1,00x40 mm	8

SW3003

Caliper Complete Repair Kit - R



VEHICLE DAF LF55 - SCHIMITZ TRAILER

NR	GTSA KOD	DESCRIPTION	QTY
1	GTW3.725	Caliper Boot & Pin Repair Kit	1
2	GTW3.735	Caliper Brake Lining Plate - R	1
3	GTW3.730	Caliper Complete Mechanism Set	1
4	GTW3.731	Caliper Needle Bearing Set	1
5	GTW3.711	Caliper Lever	1

NR	GTSA KOD	DESCRIPTION	QTY
6	365.09	Caliper Head Gasket	1
7	365.08	Caliper Head Seal	1
8	365.13	Caliper Head Seal - Short	1
9	355.03	Caliper Head Bolt - M10x1,00x40 mm	8

WBC

19,5"/ 22,5" Double Piston

GTW3.721 Caliper Boot & Pin Repair Kit

OEM NO: WBC 12 999 746 - DF 1440505 - RNLTL 5021 858 722

VEHICLE: DAF LF55 - RENAULT MIDLUM M113

NR	GTSA KOD	DESCRIPTION	QTY
1	368.03	Caliper Tappet & Boot Set - Ø69,50 mm	2
2	351.03	Caliper Pin - Ø38x118 mm	1
3	351.04	Caliper Pin - Ø37,7x76 mm	1
4	355.02	Caliper Pin Bolt - M16x1,50x120 mm	1
5	155.01.01	Caliper Pin Bolt - M16x1,50x80 mm	1
6	371.03	Caliper Pin Cap - Ø42x29 mm	1
7	371.02	Caliper Pin Cap - Ø42x17 mm	1
8	361.02	Caliper Pin Bush - Ø42xØ38x30 mm	3
9	365.05	Caliper Tappet Boot - White	2
10	375.01	Caliper Pin Boot Ring - Ø44,50x1,25 mm	2
11	365.07	Caliper Head Cap	2
12	391.01	Caliper Tappet Ring	2

GTW3.782 Caliper Pin Repair Kit

OEM NO: WBC 12 999 678 - DF 865966 - RNLTL 5021 170 488

VEHICLE: FRUEHAUF TRAILER - SMB Axle

NR	GTSA KOD	DESCRIPTION	QTY
1	351.06	Caliper Pin - Ø38x128 mm	1
2	351.06	Caliper Pin - Ø38x128 mm	1
3	351.07	Caliper Pin - Ø37,7x70 mm	1
4	355.06	Caliper Pin Bolt - M16x1,50x130 mm	1
5	155.01.01	Caliper Pin Bolt - M16x1,50x80 mm	1
6	361.02	Caliper Pin Bush - Ø42xØ38x30 mm	3
7	365.05	Caliper Tappet Boot - White	2
8	375.01	Caliper Pin Boot Ring - Ø44,50x1,25 mm	2
9	371.02	Caliper Pin Cap - Ø42x17 mm	1
10	365.12	Caliper Pin Bellow Cap Ring - Ø57xØ42x11 mm	1
11	365.12	Caliper Pin Bellow Cap Ring - Ø57xØ42x11 mm	1
12	365.11	Calipe Pin Bellow Cap	1

GTW3.7021 Caliper Boot & Pin Repair Kit

OEM NO: WBC 12 999 677 - DF 865965 - RNLTL 5021 170 487

VEHICLE:

NR	GTSA KOD	DESCRIPTION	QTY
1	368.03	Caliper Tappet & Boot Set - Ø69,50 mm	2
2	355.06	Caliper Pin Bolt - M16x1,50x130 mm	1
3	155.01.01	Caliper Pin Bolt - M16x1,50x80 mm	1
4	365.05	Caliper Tappet Boot - White	2
5	375.01	Caliper Pin Boot Ring - Ø44,50x1,25 mm	2
6	371.02	Caliper Pin Cap - Ø42x17 mm	1
7	365.12	Caliper Pin Bellow Cap Ring - Ø57xØ42x11 mm	1
8	365.11	Calipe Pin Bellow Cap	1
9	365.07	Caliper Head Cap	2

GTW3.777

Caliper Mechanism Repair Kit



NR	GTSA KOD	DESCRIPTION	QTY
1	365.08	Caliper Head Seal	2
2	391.40	Caliper Mechanism Spring	2
3	368.02	Caliper Mechanism Pin	2
4	391.35	Caliper Mechanism Washer	4
5	3.715-1	Caliper Mechanism Gear - L	1
6	3.715	Caliper Mechanism Gear - R	1
7	391.36	Caliper Mechanism Circlip	2

OEM NO

VEHICLE

GTW3.732

Caliper Tappet & Boot Set



NR	GTSA KOD	DESCRIPTION	QTY
1	368.03	Caliper Tappet & Boot Set - Ø69,50 mm	2
2	391.01	Caliper Tappet Ring	2
3	365.06	Caliper Tappet Boot	2

GTW3.781

Caliper Mechanism Pin Set



NR	GTSA KOD	DESCRIPTION	QTY
1	368.02	Caliper Mechanism Pin	2
2	391.35	Caliper Mechanism Washer	4
3	391.36	Caliper Mechanism Circlip	2

GTW3.723

Caliper Calibration Bolt Set - L



NR	GTSA KOD	DESCRIPTION	QTY
1	3.723	Caliper Calibration Bolt - L	1
2	391.06	Caliper Calibration Bolt Locking Plate	1
3	391.07	Caliper Calibration Bolt Ring	1

GTW3.722

Caliper Calibration Bolt Set - R



NR	GTSA KOD	DESCRIPTION	QTY
1	3.722	Caliper Calibration Bolt - R	1
2	391.06	Caliper Calibration Bolt Locking Plate	1
3	391.07	Caliper Calibration Bolt Ring	1

WBC

19,5"/ 22,5" Double Piston

GTW3.715

Caliper Mechanism Gear Set



NR	GTSA KOD	DESCRIPTION	QTY
1	3.715-1	Caliper Mechanism Gear - L	1
2	3.715	Caliper Mechanism Gear - R	1

GTW3.746

Caliper Shaft Housing Set



NR	GTSA KOD	DESCRIPTION	QTY
1	3.746	Caliper Shaft Housing	
2	391.05	Caliper Shaft Housing Spring	

GTW3.749

Caliper Needle Bearing Set



NR	GTSA KOD	DESCRIPTION	QTY
1	381.02	Caliper Needle Bearing	2

GTW3.750

Caliper Needle Bearing Set



NR	GTSA KOD	DESCRIPTION	QTY
1	381.03	Caliper Needle Bearing	2

GTW3.712

Caliper Pin Boot Ring Set

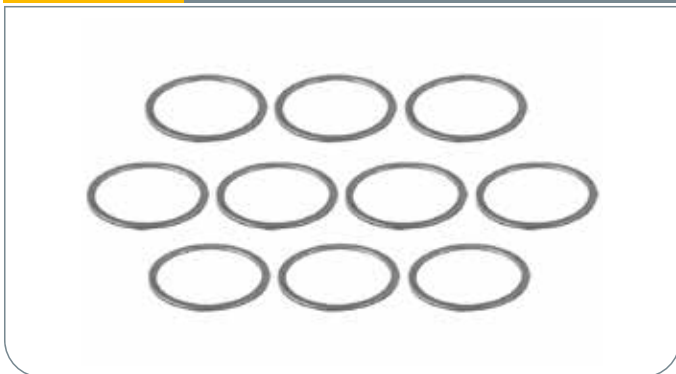

NR	GTSA KOD	DESCRIPTION	QTY
1	375.01	Caliper Pin Boot Ring - Ø44,50x1,25 mm	10

GTW3.743

Caliper Head Gasket Set





NR	GTSA KOD	DESCRIPTION	QTY
1	3.743	Caliper Head Gasket	1
2	355.03	Caliper Head Bolt - M10x1,00x40 mm	2
3	255.07	Caliper Head Bolt - M16x1,50x40 mm	5

3.723	Caliper Calibration Bolt - L
	
OEM NO	
VEHICLE	

3.722	Caliper Calibration Bolt - R
	
OEM NO	
VEHICLE	

GTW3.775	Caliper Bearing Saddle
	
OEM NO	
VEHICLE	

391.37	Caliper Lever Gear
	
OEM NO	
VEHICLE	

GTW3.716	Caliper Lever - With Mechanism
	
OEM NO	
VEHICLE	

GTW3.776	Caliper Lever Mechanism Repair Kit
	
OEM NO	
VEHICLE	

WBC

19,5"/ 22,5" Double Piston

GTW3.756

Brake Pad Retainer Repair Kit



OEM NO

VEHICLE

DAF LF55

SW3006

Caliper Complete Repair Kit



VEHICLE DAF LF55 - RENAULT MIDLUM M113

NR	GTSA KOD	DESCRIPTION	QTY	NR	GTSA KOD	DESCRIPTION	QTY
1	GTW3.721	Caliper Boot & Pin Repair Kit	1	6	GTW3.750	Caliper Needle Bearing Set	1
2	GTW3.746	Caliper Shaft Housing Set	1	7	GTW3.749	Caliper Needle Bearing Set	1
3	GTW3.723	Caliper Calibration Bolt Set - L	1	8	GTW3.777	Caliper Mechanism Repair Kit	1
4	GTW3.722	Caliper Calibration Bolt Set - R	1	9	GTW3.716	Caliper Lever - With Mechanism	1
5	GTW3.743	Caliper Head Gasket Set	1	10	GTW3.775	Caliper Bearing Saddle	1

SW3007

Caliper Complete Repair Kit



VEHICLE FRUEHAUF TRAILER - SMB Axle

NR	GTSA KOD	DESCRIPTION	QTY	NR	GTSA KOD	DESCRIPTION	QTY
1	GTW3.782	Caliper Pin Repair Kit	1	7	GTW3.750	Caliper Needle Bearing Set	1
2	368.03	Caliper Tappet & Boot Set - Ø69,50 mm	2	8	GTW3.749	Caliper Needle Bearing Set	1
3	GTW3.746	Caliper Shaft Housing Set	1	9	GTW3.777	Caliper Mechanism Repair Kit	1
4	GTW3.723	Caliper Shaft Housing Set	1	10	GTW3.716	Caliper Lever - With Mechanism	1
5	GTW3.722	Caliper Calibration Bolt Set - R	1	11	GTW3.775	Caliper Bearing Saddle	1
6	GTW3.743	Caliper Head Gasket Set	1				

WBC MAXX 17

GTW3.7022 Caliper Boot & Pin Repair Kit



OEM NO 640 317 928 2

VEHICLE RENAULT MIDLUM - VOLVO FLII/FLIII

NR	GTSA KOD	DESCRIPTION	QTY
1	351.10	Caliper Pin - Ø30x91 mm (31,00 mm)	1
2	351.11	Caliper Pin - Ø30x77 mm (17,50 mm)	1
3	355.08	Caliper Pin Bolt - M16x1,50x80 mm	2
4	361.05	Caliper Pin Bush - Ø34xØ30x25 mm	3
5	371.01	Caliper Pin Cap - Ø34x17 mm	2
6	365.16	Caliper Tappet Boot	3
7	371.01	Caliper Pin Cap - Ø34x17 mm	2
8	365.16	Caliper Tappet Boot	1
9	365.01	Caliper Pin Boot	2
10	365.07	Caliper Head Cap	1

GTW3.7008 Caliper Boot & Pin Bolt Repair Kit



OEM NO 640 317 922 2

VEHICLE

NR	GTSA KOD	DESCRIPTION	QTY
1	355.08	Caliper Pin Bolt - M16x1,50x80 mm	2
2	361.05	Caliper Pin Bush - Ø34xØ30x25 mm	3
3	371.01	Caliper Pin Cap - Ø34x17 mm	2
4	365.16	Caliper Tappet Boot	1
5	365.01	Caliper Pin Boot	2

GTW3.783 Caliper Tappet Boot & Cap Set



OEM NO 640 175 920 2

VEHICLE

NR	GTSA KOD	DESCRIPTION	QTY
1	365.04	Caliper Tappet Boot	1
2	365.08	Caliper Head Seal	1
3	365.07	Caliper Head Cap	1

GTW3.7010



OEM NO

VEHICLE

NR	GTSA KOD	DESCRIPTION	QTY
1	368.08	Caliper Adjusting Mechanism Slot	1
2	GTW3.7011	Caliper Calibration Bolt	1
3	391.41	Mechanism Torsion Spring Ring - Ø39xØ34x28,75 mm	1
4	391.23	Mechanism Torsion Spring Ring - Ø39xØ34x13,80 mm	1
5	391.24	Mechanism Torsion Spring - Ø42,60x25 mm	1

GTW3.7014

Caliper Adjusting Mechanism Washer Set



OEM NO

VEHICLE

NR	GTSA KOD	DESCRIPTION	QTY
1	391.28	Mechanism Bevel Washer - Ø35,30xØ24,30 mm	3
2	391.26	Mechanism Bevel Washer - Ø46,75xØ34,50 mm	1
3	391.27	Mechanism Bottom Washer - Ø52,70xØ41 mm	1
4	391.42	Mechanism Triangle Washer	1
5	391.29	Mechanism Clips - Small	1
6	391.30	Mechanism Clips - Big	1

GTW3.7024

Caliper Complete Mechanism Set



NR	GTSA KOD	DESCRIPTION	QTY
1	GTW3.7010	Caliper Calibration Bolt Set	1
2	GTW3.7014	Caliper Adjusting Mechanism Washer Set	1
3	GTW3.7012	Caliper Shaft Housing Set	1

GTW3.726

Caliper Head Gasket Set



NR	GTSA KOD	DESCRIPTION	QTY
1	365.09	Caliper Head Gasket	1
2	365.08	Caliper Head Seal	1
3	365.07	Caliper Head Cap	1

WBC MAXX 17

GTW3.731 Caliper Needle Bearing Set



NR	GTSA KOD	DESCRIPTION	QTY
1	381.01	Caliper Needle Bearing	2

GTW3.7013 Caliper Lever



OEM NO	
VEHICLE	

GTW3.710 Caliper Brake Lining Plate - L - (With Groove)



OEM NO	
VEHICLE	

GTW3.709 Caliper Brake Lining Plate - R - (With Groove)



OEM NO	
VEHICLE	

GTW3.7009 Caliper Calibration Bolt



OEM NO	
VEHICLE	

GTW3.7012 Caliper Shaft Housing Set



OEM NO	
VEHICLE	

SW3010

Caliper Complete Repair Kit - L



VEHICLE RENAULT MIDLUM - VOLVO FLII/FLIII

NR	GTSA KOD	DESCRIPTION	QTY	NR	GTSA KOD	DESCRIPTION	QTY
1	GTW3.7022	Caliper Boot & Pin Repair Kit	1	5	GTW3.7013	Caliper Lever	1
2	GTW3.710	Caliper Brake Lining Plate - L - (With Groove)	1	6	365.09	Caliper Head Gasket	1
3	GTW3.7024	Caliper Complete Mechanism Set	1	7	365.08	Caliper Head Seal	1
4	GTW3.731	Caliper Needle Bearing Set	1	8	355.03	Caliper Head Bolt - M10x1,00x40 mm	8

SW3011

Caliper Complete Repair Kit - R



VEHICLE RENAULT MIDLUM - VOLVO FLII/FLIII

NR	GTSA KOD	DESCRIPTION	QTY	NR	GTSA KOD	DESCRIPTION	QTY
1	GTW3.7022	Caliper Boot & Pin Repair Kit	1	5	GTW3.7013	Caliper Lever	1
2	GTW3.709	Caliper Brake Lining Plate - R - (With Groove)	1	6	365.09	Caliper Head Gasket	1
3	GTW3.7024	Caliper Complete Mechanism Set	1	7	365.08	Caliper Head Seal	1
4	GTW3.731	Caliper Needle Bearing Set	1	8	355.03	Caliper Head Bolt - M10x1,00x40 mm	8

WBC MAXX 22

GTW3.771 Caliper Boot & Pin Repair Kit

OEM NO: MN 81.50822.6038 - WBC 640 322 926 2

VEHICLE: MAN TGX/TGS

NR	GTSA KOD	DESCRIPTION	QTY
1	351.03	Caliper Pin - Ø38x118 mm	1
2	351.04	Caliper Pin - Ø37.7x76 mm	1
3	355.02	Caliper Pin Bolt - M16x1,50x120 mm	1
4	155.01.01	Caliper Pin Bolt - M16x1,50x80 mm	1
5	361.04	Caliper Pin Bush - Ø42xØ38x35 mm	3
6	371.02	Caliper Pin Cap - Ø42x17 mm	2
7	365.04	Caliper Tappet Boot	1
8	365.03	Caliper Tappet Boot	1
9	365.03	Caliper Pin Boot	2
10	375.01	Caliper Pin Boot Ring - Ø44,50x1,25 mm	2
11	365.07	Caliper Head Cap	1
12			

GTW3.771-1 Caliper Boot & Pin Bush Set

OEM NO:

VEHICLE:

NR	GTSA KOD	DESCRIPTION	QTY
1	361.04	Caliper Pin Bush - Ø42xØ38x35 mm	3
2	371.02	Caliper Pin Cap - Ø42x17 mm	2
3	365.04	Caliper Tappet Boot	1
4	365.03	Caliper Pin Boot	2
5	375.01	Caliper Pin Boot Ring - Ø44,50x1,25 mm	2
6	365.07	Caliper Head Cap	1

GTW3.768 Caliper Manual Adjuster Repair Kit

OEM NO: MN 81.50822.6039 - WBC 640 322 927 2

VEHICLE:

NR	GTSA KOD	DESCRIPTION	QTY
1	391.34	Caliper Manual Adjuster Shaft	1
2	391.33	Caliper Manual Adjuster Gear	1
3	365.14	Caliper Head Seal	1
4	365.07	Caliper Head Cap	1

GTW3.761

Caliper Calibration Bolt Set



OEM NO

VEHICLE

NR	GTSA KOD	DESCRIPTION	QTY
1	3.761	Caliper Adjusting Mechanism Slot	1
2	GTW3.779	Caliper Calibration Bolt	1
3	391.21	Mechanism Torsion Spring Ring - Ø33,75x30,40 mm	1
4	391.23	Mechanism Torsion Spring Ring - Ø39xØ34x13,80	1
5	391.24	Mechanism Torsion Spring - Ø42,60x25 mm	1
6	391.22	Mechanism Gear	1

GTW3.764

Caliper Adjusting Mechanism Washer Set



OEM NO

VEHICLE

NR	GTSA KOD	DESCRIPTION	QTY
1	391.28	Mechanism Bevel Washer - Ø35,30xØ24,30 mm	3
2	391.26	Mechanism Bevel Washer - Ø46,75xØ34,50 mm	1
3	391.27	Mechanism Bottom Washer - Ø52,70xØ41 mm	1
4	391.29	Mechanism Clips - Small	1
5	391.30	Mechanism Clips - Big	1

GTW3.769-1

Caliper Cover Set



OEM NO

640 322 650 4

VEHICLE

NR	GTSA KOD	DESCRIPTION	QTY
1	3.769	Caliper Cover	1
2	365.15	Caliper Cover Seal	1
3	155.09	Caliper Cover Bolt - M8x1,25x16 mm	6

WBC MAXX 22

GTW3.752

Caliper Boot Set



NR	GTSA KOD	DESCRIPTION	QTY
1	365.04	Caliper Tappet Boot	1
2	365.03	Caliper Pin Boot	2
3	375.01	Caliper Pin Boot Ring - Ø44,50x1,25 mm	2

GTW3.767

Caliper Adjusting Mechanism Shield & Seal Set



NR	GTSA KOD	DESCRIPTION	QTY
1	391.31	Caliper Adjusting Mechanism Shield - Ø52,80xØ51,70x14,80 mm	1
2	391.32	Caliper Adjusting Mechanism Seal	1

GTW3.772

Caliper Complete Mechanism Set



NR	GTSA KOD	DESCRIPTION	QTY
1	GTW3.761	Caliper Calibration Bolt Set	1
2	GTW3.764	Caliper Adjusting Mechanism Washer Set	1
3	GTW3.763	Caliper Shaft Housing Set	1

GTW3.766

Caliper Bearing Set



NR	GTSA KOD	DESCRIPTION	QTY
1	381.04	Caliper Needle Bearing	2
2	381.05	Caliper Lever Bearing	2
3	381.06	Caliper Lever Roller Bearing	2

GTW3.770

Caliper Cover Seal Set



NR	GTSA KOD	DESCRIPTION	QTY
1	365.15	Caliper Cover Seal	10

GTW3.765

Caliper Needle Bearing Set



NR	GTSA KOD	DESCRIPTION	QTY
1	381.04	Caliper Needle Bearing	2

GTW3.779

Caliper Calibration Bolt



OEM NO

VEHICLE

GTW3.7015

Brake Pad Retainer Repair Kit



OEM NO

640 322 933 2 - S - 81.50820.6065 - S

VEHICLE

GTW3.762

Kaliper Hareket Kolu



OEM NO

VEHICLE

GTW3.763

Caliper Shaft Housing Set



OEM NO

100831

VEHICLE

GTW3.760

Caliper Brake Lining Plate - L



OEM NO

WBC 640 322 931 2 - L - MN 81.50822.6041 - L - DAEWOO
P3093000480 - L

VEHICLE

GTW3.759

Caliper Brake Lining Plate - R



OEM NO

WBC 640 322 931 2 - R - MN 81.50822.6041 - R - DAEWOO
P3093000480 - R

VEHICLE

WBC MAXX 22

SW3005/L

Caliper Complete Repair Kit - L



VEHICLE MAN TGX/TGS

NR	GTSA KOD	DESCRIPTION	QTY	NR	GTSA KOD	DESCRIPTION	QTY
1	GTW3.771	Caliper Boot & Pin Repair Kit	1	7	GTW3.769-1	Caliper Cover Set	1
2	GTW3.760	Caliper Brake Lining Plate - L	1	8	GTW3.767	Caliper Adjusting Mechanism Shield & Seal Set	1
3	GTW3.772	Caliper Complete Mechanism Set	1	9	391.34	Caliper Manual Adjuster Shaft	1
4	GTW3.765	Caliper Needle Bearing Set	1	10	391.33	Caliper Manual Adjuster Gear	1
5	GTW3.762	Caliper Lever	1	11	365.14	Caliper Head Seal	1
6	381.06	Caliper Lever Roller Bearing	2				

SW3005/R

Caliper Complete Repair Kit - R



VEHICLE MAN TGX/TGS

NR	GTSA KOD	DESCRIPTION	QTY	NR	GTSA KOD	DESCRIPTION	QTY
1	GTW3.771	Caliper Boot & Pin Repair Kit	1	7	GTW3.769-1	Caliper Cover Set	1
2	GTW3.759	Caliper Brake Lining Plate - R	1	8	GTW3.767	Caliper Adjusting Mechanism Shield & Seal Set	1
3	GTW3.772	Caliper Complete Mechanism Set	1	10	391.34	Caliper Manual Adjuster Shaft	1
4	GTW3.765	Caliper Needle Bearing Set	1	11	391.33	Caliper Manual Adjuster Gear	1
5	GTW3.762	Caliper Lever	1	12	365.14	Caliper Head Seal	1
6	381.06	Caliper Lever Roller Bearing	2				

GTW3.7003 Caliper Boot & Pin Repair Kit

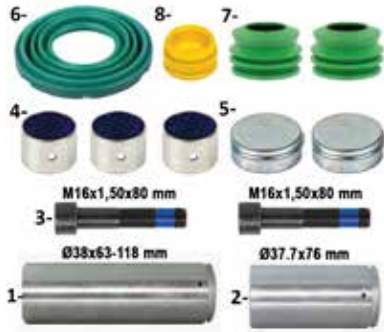

OEM NO	WBC 640 322 938 2 - DAE P3093000460
VEHICLE	RENAULT MIDLUM - VOLVO FLII/FLIII

NR	GTSA KOD	DESCRIPTION	QTY
1	351.08	Caliper Pin - Ø38x63-118 mm	1
2	351.09	Caliper Pin - Ø37.7x76 mm	1
3	355.08	Caliper Pin Bolt - M16x1,50x80 mm	2
4	361.02	Caliper Pin Bush - Ø42xØ38x30 mm	3
5	371.02	Caliper Pin Cap - Ø42x17 mm	2
6	365.04	Caliper Tappet Boot	1
7	365.03-1	Caliper Pin Boot	2
8	365.07	Caliper Head Cap	1

GTW3.7016 Caliper Pin Repair Kit

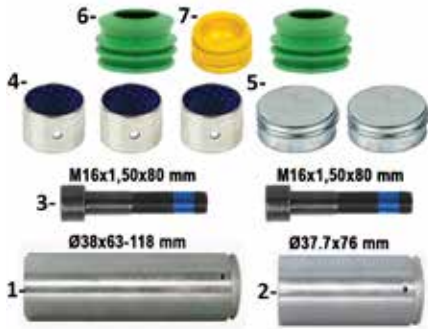

OEM NO	640 322 951 2
VEHICLE	

NR	GTSA KOD	DESCRIPTION	QTY
1	351.08	Caliper Pin - Ø38x63-118 mm	1
2	351.09	Caliper Pin - Ø37.7x76 mm	1
3	355.08	Caliper Pin Bolt - M16x1,50x80 mm	2
4	361.02	Caliper Pin Bush - Ø42xØ38x30 mm	3
5	371.02	Caliper Pin Cap - Ø42x17 mm	2
6	365.03-1	Caliper Pin Boot	2
7	365.07	Caliper Head Cap	1

GTW3.761 Caliper Calibration Bolt Set



OEM NO	
VEHICLE	

NR	GTSA KOD	DESCRIPTION	QTY
1	3.761	Caliper Adjusting Mechanism Slot	1
2	GTW3.779	Caliper Calibration Bolt	1
3	391.21	Mechanism Torsion Spring Ring - Ø33,75x30,40 mm	1
4	391.23	Mechanism Torsion Spring Ring - Ø39xØ34x13,80	1
5	391.24	Mechanism Torsion Spring - Ø42,60x25 mm	1
6	391.22	Mechanism Gear	1

WBC MAXX 22L

GTW3.764 Caliper Adjusting Mechanism Washer Set



OEM NO

VEHICLE

NR	GTSA KOD	DESCRIPTION	QTY
1	391.28	Mechanism Bevel Washer - Ø35,30xØ24,30 mm	3
2	391.26	Mechanism Bevel Washer - Ø46,75xØ34,50 mm	1
3	391.27	Mechanism Bottom Washer - Ø52,70xØ41 mm	1
4	391.29	Mechanism Clips - Small	1
5	391.30	Mechanism Clips - Big	1

GTW3.768 Caliper Manual Adjuster Repair Kit



OEM NO

MN 81.50822.6039 - WBC 640 322 927 2

VEHICLE

NR	GTSA KOD	DESCRIPTION	QTY
1	391.34	Caliper Manual Adjuster Shaft	1
2	391.33	Caliper Manual Adjuster Gear	1
3	365.14	Caliper Head Seal	1
4	365.07	Caliper Head Cap	1

GTW3.7018 Caliper Tappet Boot & Cap Set



OEM NO

640 322 942 2

NR	GTSA KOD	DESCRIPTION	QTY
1	365.04	Caliper Tappet Boot	1
2	365.07	Caliper Head Cap	1

GTW3.7017 Caliper Boot Set



OEM NO

NR	GTSA KOD	DESCRIPTION	QTY
1	365.04	Caliper Tappet Boot	1
2	365.03-1	Caliper Pin Boot	2

GTW3.769-1 Caliper Cover Set



OEM NO 640 322 650 4

VEHICLE

NR	GTSA KOD	DESCRIPTION	QTY
1	3.769	Caliper Cover	1
2	365.15	Caliper Cover Seal	1
3	155.09	Caliper Cover Bolt - M8x16 mm	6

GTW3.766 Caliper Bearing Set



NR	GTSA KOD	DESCRIPTION	QTY
1	381.04	Caliper Needle Bearing	2
2	381.05	Caliper Lever Bearing	2
3	381.06	Caliper Lever Roller Bearing	2

GTW3.7029 Caliper Adjusting Mechanism Shield & Seal Set



NR	GTSA KOD	DESCRIPTION	QTY
1	GTW3.761	Caliper Calibration Bolt Set	1
2	GTW3.764	Caliper Adjusting Mechanism Washer Set	1
3	GTW3.7019	Caliper Shaft Housing Set	1

GTW3.770 Caliper Cover Seal Set



NR	GTSA KOD	DESCRIPTION	QTY
1	365.15	Caliper Cover Seal	10

GTW3.765 Caliper Needle Bearing Set



NR	GTSA KOD	DESCRIPTION	QTY
1	381.04	Caliper Needle Bearing	2

WBC MAXX 22L

GTW3.779

Caliper Calibration Bolt



OEM NO

VEHICLE

GTW3.7019

Caliper Shaft Housing Set



OEM NO

VEHICLE

GTW3.7015

Brake Pad Retainer Repair Kit



OEM NO

640 322 933 2 - S - 81.50820.6065 - S

VEHICLE

GTW3.7025

Caliper Lever



OEM NO

VEHICLE

MB AROCS Rear

GTW3.759

Caliper Brake Lining Plate - R



OEM NO

WBC 640 322 9312 - R - MN 81.50822.6041 - R - DAEWOO
P3093000480 - R

VEHICLE

GTW3.760

Caliper Brake Lining Plate - L



OEM NO

WBC 640 322 9312 - L - MN 81.50822.6041 - L - DAEWOO
P3093000480 - L

VEHICLE

SW3014

Caliper Complete Repair Kit - L



VEHICLE MB Arocs Rear

NR	GTSA KOD	DESCRIPTION	QTY	NR	GTSA KOD	DESCRIPTION	QTY
1	GTW3.7003	Caliper Boot & Pin Repair Kit	1	7	GTW3.769-1	Caliper Cover Set	1
2	GTW3.760	Caliper Brake Lining Plate - L	1	8	GTW3.767	Caliper Adjusting Mechanism Shield & Seal Set	1
3	GTW3.7029	Caliper Complete Mechanism Set	1	9	391.34	Caliper Manual Adjuster Shaft	1
4	GTW3.765	Caliper Needle Bearing Set	1	10	391.33	Caliper Manual Adjuster Gear	1
5	GTW3.7025	Caliper Lever	1	11	365.14	Caliper Head Seal	1
6	381.06	Caliper Lever Bearing	2				

SW3013

Caliper Complete Repair Kit - R



VEHICLE MB Arocs Rear

NR	GTSA KOD	DESCRIPTION	QTY	NR	GTSA KOD	DESCRIPTION	QTY
1	GTW3.7003	Caliper Boot & Pin Repair Kit	1	7	GTW3.769-1	Caliper Cover Set	1
2	GTW3.759	Caliper Brake Lining Plate - R	1	8	GTW3.767	Caliper Adjusting Mechanism Shield & Seal Set	1
3	GTW3.7029	Caliper Complete Mechanism Set	1	9	391.34	Caliper Manual Adjuster Shaft	1
4	GTW3.765	Caliper Needle Bearing Set	1	10	391.33	Caliper Manual Adjuster Gear	1
5	GTW3.7025	Caliper Lever	1	11	365.14	Caliper Head Seal	1
6	381.06	Caliper Lever Bearing	2				

WBC MAXX 22T

GTW3.7003 Caliper Boot & Pin Repair Kit



OEM NO WBC 640 322 938 2 - DAE P3093000460

VEHICLE RENAULT MIDLUM - VOLVO FLII/FLIII

NR	GTSA KOD	DESCRIPTION	QTY
1	351.8	Caliper Pin - Ø38xØ63x118 mm	1
2	351.09	Caliper Pin - Ø37.7x76 mm	1
3	355.08	Caliper Pin Bolt - M16x1,50x80 mm	2
4	361.02	Caliper Pin Bush - Ø42xØ38x30 mm	3
5	371.02	Caliper Pin Cap - Ø42x17 mm	2
6	365.04	Caliper Tappet Boot	1
7	365.03-1	Caliper Pin Boot	2
8	365.07	Caliper Head Cap	1

GTW3.7014 Caliper Adjusting Mechanism Washer Set



OEM NO

VEHICLE

NR	GTSA KOD	DESCRIPTION	QTY
1	391.28	Mechanism Bevel Washer - Ø35,30xØ24,30 mm	3
2	391.26	Mechanism Bevel Washer - Ø46,75xØ34,50 mm	1
3	391.27	Mechanism Bottom Washer - Ø52,70xØ41 mm	1
4	391.29	Mechanism Clips - Small	1
5	391.3	Mechanism Clips - Big	1
6	391.44	Mechanism Triangle Washer	1

GTW3.7020 Caliper Calibration Bolt Set



OEM NO

VEHICLE

NR	GTSA KOD	DESCRIPTION	QTY
1	368.09	Caliper Adjusting Mechanism Slot	1
2	GTW3.779	Caliper Calibration Bolt	1
3	391.21	Mechanism Torsion Spring Ring - Ø33,75x30,40 mm	1
4	391.23	Mechanism Torsion Spring Ring - Ø39xØ34x13,80	1
5	391.24	Mechanism Torsion Spring - Ø42,60x25 mm	1

GTW3.7001

Caliper Complete Mechanism Set



NR	GTSA KOD	DESCRIPTION	QTY
1	GTW3.7020	Caliper Calibration Bolt Set	1
2	GTW3.7014	Caliper Adjusting Mechanism Washer Set	1
3	GTW3.7023	Caliper Shaft Housing Set	1

GTW3.766

Caliper Bearing Set



NR	GTSA KOD	DESCRIPTION	QTY
1	381.04	Caliper Needle Bearing	2
2	381.05	Caliper Lever Bearing	2
3	381.06	Caliper Lever Roller Bearing	2

GTW3.7026

Caliper Cover Set



NR	GTSA KOD	DESCRIPTION	QTY
1	37.026	Caliper Cover (With Gasket)	1
2	155.09	Caliper Cover Bolt - M8x1,25x16 mm	6

GTW3.765

Caliper Needle Bearing Set



NR	GTSA KOD	DESCRIPTION	QTY
1	381.04	Caliper Needle Bearing	2

GTW3.734

Caliper Brake Lining Plate - L



OEM NO	640 225 926 2 - L
VEHICLE	

GTW3.733

Caliper Brake Lining Plate - R



OEM NO	640 225 926 2 - R
VEHICLE	

WBC
MAXX 22T

GTW3.7023 Caliper Shaft Housing Set



OEM NO

VEHICLE

GTW3.779 Caliper Calibration Bolt



OEM NO

VEHICLE

GTW3.7015 Brake Pad Retainer Repair Kit



OEM NO

640 322 933 2 - S - 81.50820.6065 - S

VEHICLE

GTW3.7000 Caliper Lever



OEM NO

VEHICLE

SW3009

Caliper Complete Repair Kit - L

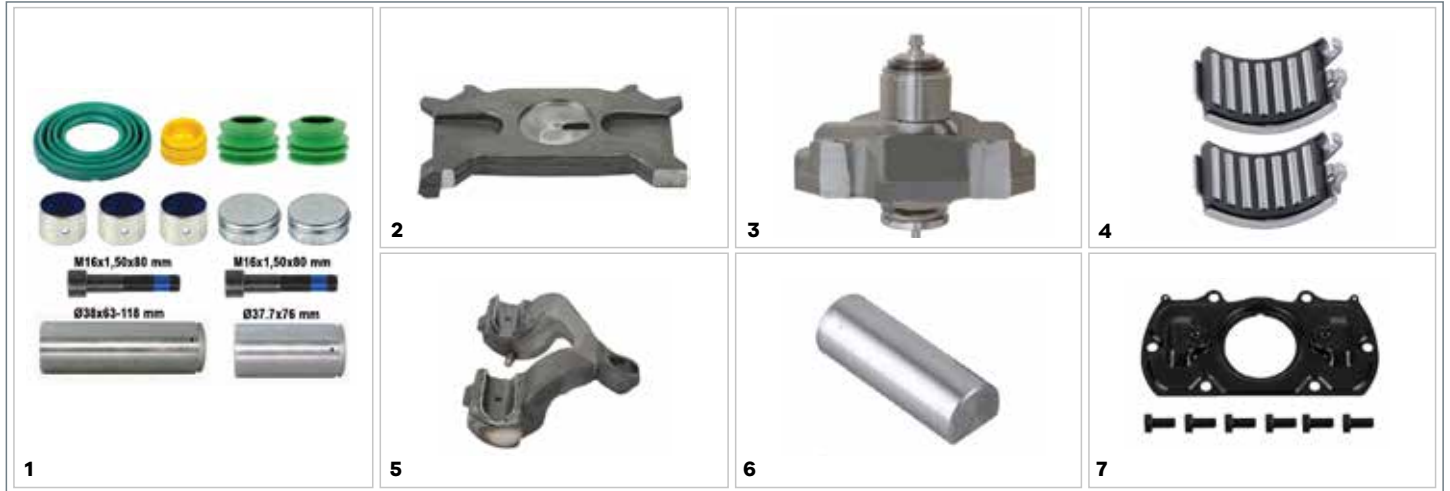

VEHICLE SCHMITZ TRAILER - HENDRICKSON TRAILER

NR	GTSA KOD	DESCRIPTION	QTY
1	GTW3.7003	Caliper Boot & Pin Repair Kit	1
2	GTW3.734	Caliper Brake Lining Plate - L	1
3	GTW3.7001	Caliper Complete Mechanism Set	1
4	GTW3.765	Caliper Needle Bearing Set	1

NR	GTSA KOD	DESCRIPTION	QTY
6	GTW3.7000	Caliper Lever	1
7	381.06	Caliper Lever Bearing	2
8	GTW3.7026	Caliper Cover Set	1

SW3008

Caliper Complete Repair Kit - R

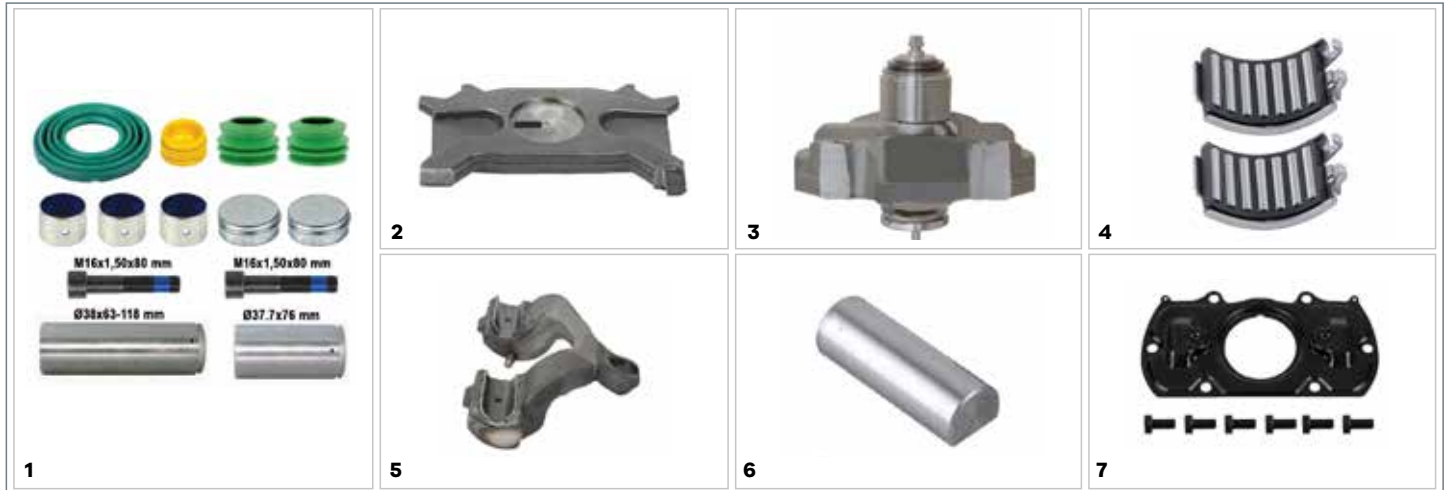

VEHICLE SCHMITZ TRAILER - HENDRICKSON TRAILER

NR	GTSA KOD	DESCRIPTION	QTY
1	GTW3.7003	Caliper Boot & Pin Repair Kit	1
2	GTW3.733	Caliper Brake Lining Plate - R	1
3	GTW3.7001	Caliper Complete Mechanism Set	1
4	GTW3.765	Caliper Needle Bearing Set	1

NR	GTSA KOD	DESCRIPTION	QTY
5	GTW3.7000	Caliper Lever	1
6	381.06	Caliper Lever Bearing	2
7	GTW3.7026	Caliper Cover Set	1

HDX

GTH5.547 Caliper Complete Mechanism Set



OEM NO

VEHICLE SAF Axle - SMB Axle

NR	GTSA KOD	DESCRIPTION	QTY
1	GTH5.500	Caliper Boot Set	1
2	GTH5.545	Caliper Tappet Plate & Bolt Set	1
3	GTH5.517	Caliper Mechanism Cap Set	1
4	GTH5.518	Caliper Mechanism Clamp Set	1
5	GTH5.515	Caliper Adjusting Mechanism	1
6	GTH5.508	Caliper Adjusting Mechanism Gear	1
7	GTH5.509	Caliper Adjusting Mechanism Gear	1
8	GTH5.516	Caliper Shaft Housing Set	1
9	GTH5.524	Caliper Intermediate Gear	1
10	GTH5.511	Caliper Needle Bearing Set	1
11	GTH5.514	Caliper Lever	1
12	GTH5.519	Caliper Lever Pin	1
13	GTH5.510	Caliper Lever Needle Bearing	1
14	GTH5.546	Caliper Mechanism Locker Plate Set	1

GTH5.555 Caliper Complete Mechanism Set



OEM NO

VEHICLE SAF Axle - SMB Axle

NR	GTSA KOD	DESCRIPTION	QTY
1	565.05	Caliper Tappet Boot - Ø78,50 mm	2
2	591.16	Boot Protection Spring - Ø78,50 mm	2
3	GTH5.539	Caliper Tappet & Calibration Bolt Set	1
4	GTH5.543	Caliper Mechanism Cap Set	1
5	GTH5.544	Caliper Mechanism Clamp Set	1
6	GTH5.540	Caliper Adjusting Mechanism	1
7	GTH5.553	Caliper Calibration Gear - L	1
8	GTH5.554	Caliper Calibration Gear - R	1
9	GTH5.548	Caliper Shaft Housing Set	1
10	GTH5.537	Caliper Needle Bearing Set	1
11	GTH5.550	Caliper Lever	1
12	GTH5.549	Caliper Needle Bearing Set	1
13	GTH5.552	Caliper Mechanism Locker Plate Set	1

GTH5.565 Caliper Pin Bolt Repair Kit



OEM NO HDX 94661 - SF 3 434 3203 00 - 3 434 3854 00 - 3 434 3854 01

VEHICLE SAF AXLE - SMB AXLE

NR	GTSA KOD	DESCRIPTION	QTY
1	565.01	Caliper Pin Boot	8
2	591.01	Caliper Pin Boot Ring - Ø39,50x4 mm	8
3	565.04	Caliper Pin Plastic Bush	4
4	571.04	Caliper Pin Steel Cap - Ø56x12 mm	4
5	555.06	Caliper Pin Bolt - M14x2,00x61 mm	4
6	555.02	Caliper Pin Bolt - M14x2,00x53 mm	4
7	571.03	Caliper Pin Cap - (Mk IV) - Ø57x40 mm	2
8	565.03	Caliper Head Plug	2
9	565.07	Caliper Head Plug O-ring - (Mk II)	2
10	565.08	Caliper Head Plug - (Mk II)	2
11	555.08	Caliper Head Plug Bolt - (Mk II)	2

HDX

MARK II /III/IV

GTH5.538

Caliper Pin Repair Kit



OEM NO

HDX 87406

VEHICLE

SAF AXLE - SMB AXLE

NR	GTSA KOD	DESCRIPTION	QTY
1	551.05	Caliper Pin - Ø35x69 mm	4
2	555.06	Caliper Pin Bolt - M14x2,00x61 mm	4
3	565.01	Caliper Pin Boot	8
4	565.04	Caliper Pin Plastic Bush	4
5	591.01	Caliper Pin Boot Ring - Ø39,50x4 mm	8
6	571.04	Caliper Pin Steel Cap - Ø56x12 mm	4
7	565.03	Caliper Head Plug	2

GTH5.566

Caliper Pin Boot & Plug Set



OEM NO

HDX 87680

VEHICLE

NR	GTSA KOD	DESCRIPTION	QTY
1	565.01	Caliper Pin Boot	8
2	565.04	Caliper Pin Plastic Bush	4
3	591.01	Caliper Pin Boot Ring - Ø39,50x4 mm	8
4	571.04	Caliper Pin Steel Cap - Ø56x12 mm	4
5	571.03	Caliper Pin Cap - (Mk IV) - Ø57x40 mm	2
6	565.03	Caliper Head Plug	2
7	565.07	Caliper Head Plug O-ring - (Mk II)	2
8	565.08	Caliper Head Plug - (Mk II)	2
9	555.08	Caliper Head Plug Bolt - (Mk II)	2

GTH5.567

Caliper Pin Boot & Plug Set



OEM NO

89723

VEHICLE

NR	GTSA KOD	DESCRIPTION	QTY
1	565.01	Caliper Pin Boot	2
2	565.04	Caliper Pin Plastic Bush	1
3	591.01	Caliper Pin Boot Ring - Ø39,50x4 mm	2
4	571.04	Caliper Pin Steel Cap - Ø56x12 mm	4
5	571.03	Caliper Pin Cap - (Mk IV) - Ø57x40 mm	2
6	565.03	Caliper Head Plug	2
7	565.07	Caliper Head Plug O-ring - (Mk II)	2
8	565.08	Caliper Head Plug - (Mk II)	2
9	555.08	Caliper Head Plug Bolt - (Mk II)	2

GTH5.570

Caliper Boot & Plug Set



OEM NO

HDX 94663

VEHICLE

NR	GTSA KOD	DESCRIPTION	QTY
1	565.05	Caliper Tappet Boot - Ø78,50 mm	2
2	591.07	Caliper Tappet Clips	2
3	565.06	Caliper Adjuster Shaft Seal	2
4	565.03	Caliper Head Plug	2
5	565.07	Caliper Head Plug O-ring - (Mk II)	2
6	565.08	Caliper Head Plug - (Mk II)	2
7	555.08	Caliper Head Plug Bolt - (Mk II)	2

GTH5.501

Caliper Pin Repair Kit



OEM NO

89541

VEHICLE

SAF AXLE - SMB AXLE

NR	GTSA KOD	DESCRIPTION	QTY
1	551.04	Caliper Pin - Ø35x70 mm	4
2	555.02	Caliper Pin Bolt - M14x2,00x53 mm	4
3	565.01	Caliper Pin Boot	8
4	565.04	Caliper Pin Plastic Bush	4
5	591.01	Caliper Pin Boot Ring - Ø39,50x4 mm	8
6	571.01	Caliper Pin Steel Cap - Ø56x12,50	4
7	571.03	Caliper Pin Cap - (Mk IV) - Ø57x40 mm	2
8	565.03	Caliper Head Plug	2

GTH5.571

Caliper Plug Set



OEM NO

HDX 87408

VEHICLE

NR	GTSA KOD	DESCRIPTION	QTY
1	565.03	Caliper Head Plug	2
2	565.07	Caliper Head Plug O-ring - (Mk II)	2
3	565.08	Caliper Head Plug - (Mk II)	2
4	555.08	Caliper Head Plug Bolt - (Mk II)	2

HDX

MARK II /III/IV

GTH5.568 Caliper Boot & Plug Set



OEM NO 87405

VEHICLE

NR	GTSA KOD	DESCRIPTION	QTY
1	565.05	Caliper Tappet Boot - Ø78,50 mm	2
2	591.16	Boot Protection Spring - Ø78,50 mm	2
3	591.07	Caliper Tappet Clips	2
4	565.03	Caliper Head Plug	2
5	565.07	Caliper Head Plug O-ring - (Mk II)	2
6	565.08	Caliper Head Plug - (Mk II)	2
7	555.08	Caliper Head Plug Bolt - (Mk II)	2

GTH5.545 Caliper Tappet Plate & Bolt Set



OEM NO

VEHICLE

NR	GTSA KOD	DESCRIPTION	QTY
1	GTH5.505	Caliper Tappet Plate	1
2	591.07	Caliper Tappet Clips	2
3	591.02	Caliper Bolt Clips	2
4	5.506	Caliper Calibration Bolt	2

GTH5.572 Caliper Boot Set



OEM NO HDX 94662

VEHICLE

NR	GTSA KOD	DESCRIPTION	QTY
1	565.02	Caliper Tappet Boot - Ø67 mm	2
2	561.01	Caliper Tappet Bush	2
3	591.07	Caliper Tappet Clips	2
4	565.03	Caliper Head Plug	1

GTH5.548 Caliper Shaft Housing Set



NR	GTSA KOD	DESCRIPTION	QTY
1	5.548	Caliper Shaft Housing	1
2	591.08	Caliper Shaft Housing Spring	1
3	591.19	Caliper Shaft Housing Ring - Ø35x4 mm	2
4	591.20	Caliper Shaft Housing Washer - Ø39x6,50 mm	2

OEM NO

VEHICLE

GTH5.516 Caliper Shaft Housing Set



NR	GTSA KOD	DESCRIPTION	QTY
1	5.516	Caliper Shaft Housing	1
2	591.08	Caliper Shaft Housing Spring	1
3	591.10	Caliper Shaft Housing Ring	1
4	591.11	Caliper Shaft Housing Wavy Washer	1
5	591.09	Caliper Shaft Housing Washer	1

OEM NO

HDX 2050 89611

VEHICLE

GTH5.574 Caliper Tappet Plate & Bolt Set



NR	GTSA KOD	DESCRIPTION	QTY
1	565.02	Caliper Tappet Boot - Ø67 mm	2
2	GTH5.505	Caliper Tappet Plate	1
3	GTH5.506	Caliper Calibration Bolt	2
4	565.03	Caliper Head Plug	1

OEM NO

HDX 94664

VEHICLE

HDX

MARK II /III/IV

GTH5.512

Caliper Adjuster Shaft



OEM NO HDX 90693 - 89926 - SF 3 434 3855 02 - RNLT 5021 174 163

VEHICLE

NR	GTSA KOD	DESCRIPTION	QTY
1	591.04	Caliper Adjuster Shaft	2
2	565.06	Caliper Adjuster Shaft Seal	2
3	565.03	Caliper Head Plug	2

GTH5.573

Caliper Spring & Plate Set



OEM NO HDX 92731

VEHICLE

NR	GTSA KOD	DESCRIPTION	QTY
1	591.15	Boot Protection Spring - Ø67 mm	2
2	GTH5.505	Caliper Tappet Plate	1
3	591.07	Caliper Tappet Clips	2

GTH5.576

Brake Pad Retainer Kit



OEM NO HDX 94659 - SF 3 434 3851 01 - RNLT 5021 174 162 - 5021 174 180

VEHICLE

NR	GTSA KOD	DESCRIPTION	QTY
1	GTH5.535	Brake Pad Retainer Repair Kit	2
2	591.22	Brake Pad Spring	4
3	565.03	Caliper Head Plug	2

GTH5.512-1 Caliper Plug Set



OEM NO	HDX 89925
VEHICLE	

NR	GTSA KOD	DESCRIPTION	QTY
1	565.03	Caliper Head Plug	2
2	565.06	Caliper Adjuster Shaft Seal	2

GTH5.535 Brake Pad Retainer Repair Kit



OEM NO	HDX 90673
VEHICLE	

NR	GTSA KOD	DESCRIPTION	QTY
1	5.535	Brake Pad Retainer Sheet Metal	1
2	555.07	Brake Pad Retainer Bolt - M10x1,50x25 mm	1

GTH5.541 Caliper Protection Spring Set



OEM NO	HDX 94665
VEHICLE	

NR	GTSA KOD	DESCRIPTION	QTY
1	591.15	Boot Protection Spring - Ø67 mm	2
2	591.07	Caliper Tappet Clips	2

HDX

MARK II /III/IV

GTH5.575

Brake Pad Retainer Repair Kit



OEM NO

HDX 91216

VEHICLE

NR	GTSA KOD	DESCRIPTION	QTY
1	GTH5.535	Brake Pad Retainer Repair Kit	1
2	591.22	Brake Pad Spring	2

GTH5.539

Caliper Tappet & Calibration Bolt Set



OEM NO

VEHICLE

NR	GTSA KOD	DESCRIPTION	QTY
1	591.14	Caliper Tappet & Calibration Bolt - L	1
2	591.13	Caliper Tappet & Calibration Bolt - R	1

GTH5.500

Caliper Boot Set



OEM NO

HDX 89794

VEHICLE

NR	GTSA KOD	DESCRIPTION	QTY
1	565.02	Caliper Tappet Boot - Ø67 mm	2
2	591.15	Boot Protection Spring - Ø67 mm	2
3	591.07	Caliper Tappet Clips	2

GTH5.569 Caliper Cap Set



OEM NO	HDX 89927
VEHICLE	

NR	GTSA KOD	DESCRIPTION	QTY
1	571.03	Caliper Pin Cap - (Mk IV) - Ø57x40 mm	2

GTH5.543 Caliper Mechanism Cap Set



NR	GTSA KOD	DESCRIPTION	QTY
1	5.532	Caliper Mechanism Cap	1
2	555.05	Caliper Mechanism Bolt- M8x60 mm	4
3	591.08	Caliper Mechanism Nut - M8	4

GTH5.546 Caliper Mechanism Locker Plate Set



NR	GTSA KOD	DESCRIPTION	QTY
1	5.546	Caliper Mechanism Locker Plate	1
2	591.04	Caliper Adjuster Shaft	2
3	565.06	Caliper Adjuster Shaft Seal	2

GTH5.517 Caliper Mechanism Cap Set



NR	GTSA KOD	DESCRIPTION	QTY
1	5.517	Caliper Mechanism Cap	1
2	555.04	Caliper Mechanism Bolt- M8x45 mm	4

GTH5.552 Caliper Mechanism Locker Plate Set



NR	GTSA KOD	DESCRIPTION	QTY
1	5.552	Caliper Mechanism Locker Plate	1
2	565.03	Caliper Head Plug	2

HDX

MARK II /III/IV

GTH5.507 Caliper Calibration Bolt Set - (Without Flange)



NR	GTSA KOD	DESCRIPTION	QTY
1	5.507	Caliper Calibration Bolt - (Without Flange)	1
2	591.02	Caliper Bolt Clips	1

GTH5.506 Caliper Calibration Bolt Set



NR	GTSA KOD	DESCRIPTION	QTY
1	5.506	Caliper Calibration Bolt	1
2	591.02	Caliper Bolt Clips	1

GTH5.511 Caliper Needle Bearing Set



NR	GTSA KOD	DESCRIPTION	QTY
1	581.02	Caliper Needle Bearing	2

GTH5.537 Caliper Needle Bearing Set



NR	GTSA KOD	DESCRIPTION	QTY
1	581.05	Caliper Needle Bearing	2

GTH5.549 Caliper Needle Bearing Set



NR	GTSA KOD	DESCRIPTION	QTY
1	581.06	Caliper Needle Bearing	2

GTH5.518 Caliper Mechanism Clamp Set

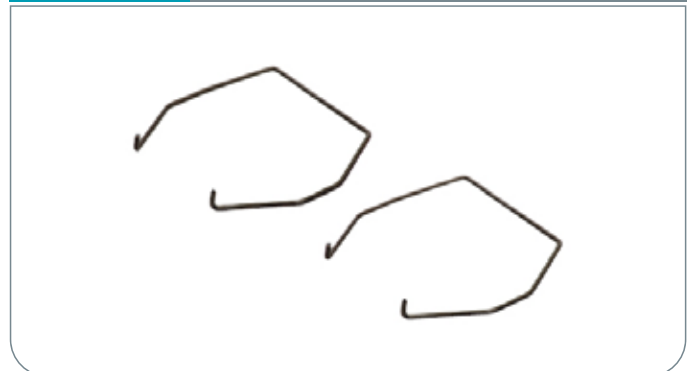

NR	GTSA KOD	DESCRIPTION	QTY
1	591.12	Caliper Mechanism Clamp	2

GTH5.544 Caliper Mechanism Clamp Set

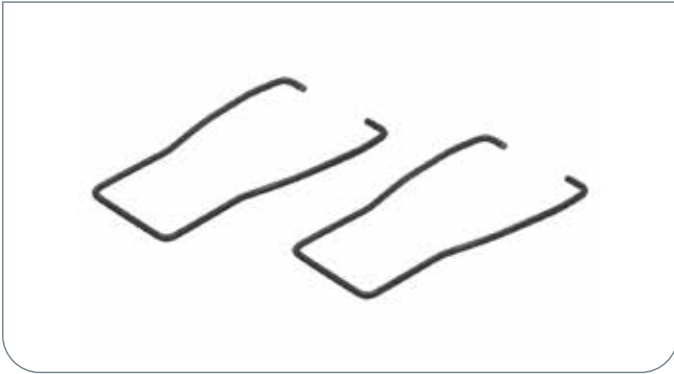

NR	GTSA KOD	DESCRIPTION	QTY
1	591.17	Caliper Mechanism Clamp	2

GTH5.553 Caliper Calibration Gear - L



OEM NO	
VEHICLE	

GTH5.550 Caliper Lever



OEM NO	
VEHICLE	

GTH5.515 Caliper Adjusting Mechanism



OEM NO	
VEHICLE	

GTH5.554 Caliper Calibration Gear - R



OEM NO	
VEHICLE	

GTH5.540 Caliper Adjusting Mechanism



OEM NO	
VEHICLE	

HDX

MARK II /III/IV

GTH5.524 Caliper Intermediate Gear



OEM NO

VEHICLE

GTH5.514 Caliper Lever



OEM NO

VEHICLE

GTH5.508 Caliper Adjusting Mechanism Gear



OEM NO

VEHICLE

GTH5.510 Caliper Lever Needle Bearing Set



OEM NO

VEHICLE

GTH5.509 Caliper Adjusting Mechanism Gear



OEM NO

VEHICLE

GTH5.519 Caliper Lever Pin



OEM NO

VEHICLE

SH5004

Caliper Complete Mechanism Set



VEHICLE	SAF Axle - SMB Axle
---------	---------------------

NR	GTSA KOD	DESCRIPTION	QTY
1	GTH5.538	Caliper Pin Repair Kit	1
2	GTH5.555	Caliper Complete Mechanism Set	1
3	GTH5.575	Brake Pad Retainer Repair Kit	1

SH5002

Caliper Complete Mechanism Set



VEHICLE	SAF Axle - SMB Axle
---------	---------------------

NR	GTSA KOD	DESCRIPTION	QTY
1	GTH5.501	Caliper Pin Repair Kit	1
2	GTH5.547	Caliper Complete Mechanism Set	1
3	GTH5.535	Brake Pad Retainer Repair Kit	1

SH5003

Caliper Complete Mechanism Set



VEHICLE	
---------	--

NR	GTSA KOD	DESCRIPTION	QTY
1	GTH5.503	Caliper Pin Repair Kit	1
2	GTH5.547	Caliper Complete Mechanism Set	1
3	GTH5.535	Brake Pad Retainer Repair Kit	1

HDX

MODUL X GEN1 GEN2

GTH5.534 Caliper Complete Mechanism Set

OEM NO

VEHICLE SAF Axle - SMB Axle - DANA Axle - GIGANT Axle - VOLVO - RENAULT

NR	GTSA KOD	DESCRIPTION	QTY
1	565.02	Caliper Tappet Boot - Ø67 mm	2
2	591.15	Boot Protection Spring - Ø67 mm	2
3	GTH5.522	Caliper Tappet Plate & Bolt	2
4	GTH5.526	Caliper Adjusting Mechanism	1
5	GTH5.523	Caliper Adjusting Mechanism Gear	1
6	GTH5.524	Caliper Intermediate Gear	1
7	GTH5.525	Caliper Adjusting Mechanism Gear	1
8	GTH5.527	Caliper Lever Needle Bearing	1
9	GTH5.528	Caliper Needle Bearing Set	1
10	GTH5.529	Caliper Shaft Housing Set	1
11	GTH5.531	Caliper Mechanism Plate	1
12	GTH5.530	Caliper Mechanism Clamp	1
13	GTH5.532	Caliper Lever	1
14	GTH5.536	Caliper Lever Pin	1
15	GTH5.533	Caliper Mechanism Cap Set	1
16	591.04	Caliper Adjuster Shaft	1
17	565.06	Caliper Adjuster Shaft Seal	1
18	565.03	Caliper Head Plug	1

GTH5.557 Caliper Complete Mechanism Set

OEM NO

VEHICLE SAF Axle - SMB Axle

NR	GTSA KOD	DESCRIPTION	QTY
1	565.02	Caliper Tappet Boot - Ø67 mm	2
2	591.15	Boot Protection Spring - Ø67 mm	2
3	GTH5.545	Caliper Tappet Plate & Bolt Set	1
4	GTH5.533	Caliper Mechanism Cap Set	1
5	GTH5.560	Caliper Mechanism Clamp - 55 mm	1
6	GTH5.515	Caliper Adjusting Mechanism	1
7	GTH5.559	Caliper Calibration Gear	1
8	GTH5.509	Caliper Calibration Gear	1
9	GTH5.516	Caliper Shaft Housing Set	1
10	GTH5.524	Caliper Intermediate Gear	1
11	GTH5.511	Caliper Needle Bearing Set	1
12	GTH5.514	Caliper Lever	1
13	GTH5.556	Caliper Lever Pin	1
14	GTH5.510	Caliper Lever Needle Bearing	1
15	591.04	Caliper Adjuster Shaft	1
16	565.06	Caliper Adjuster Shaft Seal	1
17	565.03	Caliper Head Plug	1

GTH5.520 Caliper Pin Repair Kit

OEM NO HDX 93299

VEHICLE SAF Axle - SMB Axle - DANA Axle - GIGANT Axle - VOLVO - RENAULT

NR	GTSA KOD	DESCRIPTION	QTY
1	551.01	Caliper Pin - Ø35x64 mm	4
2	555.01	Caliper Pin Bolt - M14x2,00x42 mm	4
3	571.02	Caliper Pin Cap - Ø42x22,50 mm	2
4	571.01	Caliper Pin Steel Cap - Ø56x12,50 mm	2
5	565.01	Caliper Pin Boot	6
6	565.04	Caliper Pin Plastic Bush	4
7	565.03	Caliper Head Plug	1

GTH5.581 Caliper Pin Repair Kit



OEM NO: HDX 91012

VEHICLE: SAF Axle - SMB Axle

NR	GTSA KOD	DESCRIPTION	QTY
1	551.02	Caliper Pin - Ø35x64 mm	4
2	555.01	Caliper Pin Bolt - M14x2,00x42 mm	4
3	571.02	Caliper Pin Cap - Ø42x22,50 mm	2
4	571.01	Caliper Pin Steel Cap - Ø56x12,50 mm	4
5	565.01	Caliper Pin Boot	6
6	565.04	Caliper Pin Plastic Bush	4
7	565.03	Caliper Head Plug	1

GTH5.577 Caliper Pin Bolt Repair Kit



OEM NO: HDX 994660 - RNLT 5021 174 174 - SF 3 434 3854 02 - 3 434 3856 01

VEHICLE: SAF Axle - SAF Axle - DANA Axle -GIGANT Axle - VOLVO - RENAULT

NR	GTSA KOD	DESCRIPTION	QTY
1	555.01	Caliper Pin Bolt - M14x2,00x42 mm	4
2	555.02	Caliper Pin Bolt - M14x2,00x53 mm	4
3	571.02	Caliper Pin Cap - Ø42x22,50 mm	2
4	571.01	Caliper Pin Steel Cap - Ø56x12,50 mm	2
5	565.01	Caliper Pin Boot	6
6	565.04	Caliper Pin Plastic Bush	4
7	565.03	Caliper Head Plug	1

GTH5.521 Caliper Pin Boot & Cap Set



OEM NO: HDX 91013

VEHICLE:

NR	GTSA KOD	DESCRIPTION	QTY
1	571.02	Caliper Pin Cap - Ø42x22,50 mm	2
2	571.01	Caliper Pin Steel Cap - Ø56x12,50 mm	4
3	565.01	Caliper Pin Boot	6
4	565.04	Caliper Pin Plastic Bush	4
5	565.03	Caliper Head Plug	1

HDX

MODUL X GEN1 GEN2

GTH5.578 Caliper Pin Boot & Cap Set



OEM NO: HDX 91014

VEHICLE

NR	GTSA KOD	DESCRIPTION	QTY
1	571.02	Caliper Pin Cap - Ø42x22,50 mm	2
2	571.01	Caliper Pin Steel Cap - Ø56x12,50 mm	4
3	565.01	Caliper Pin Boot	2
4	565.04	Caliper Pin Plastic Bush	1
5	565.03	Caliper Head Plug	1

GTH5.516 Caliper Shaft Housing Set



OEM NO: HDX 2050 89611

VEHICLE

NR	GTSA KOD	DESCRIPTION	QTY
1	5.516	Caliper Shaft Housing	1
2	591.08	Caliper Shaft Housing Spring	1
3	591.10	Caliper Shaft Housing Ring	1
4	591.11	Caliper Shaft Housing Wavy Washer	1
5	591.09	Caliper Shaft Housing Washer	1

GTH5.500-1 Caliper Boot Set



OEM NO: HDX 91011

VEHICLE

NR	GTSA KOD	DESCRIPTION	QTY
1	565.02	Caliper Tappet Boot - Ø67 mm	2
2	591.15	Boot Protection Spring - Ø67 mm	2
3	591.02	Caliper Bolt Clips	1
4	565.03	Caliper Head Plug	1

GTH5.529 Caliper Shaft Housing Set



OEM NO: HDX 92909

VEHICLE

NR	GTSA KOD	DESCRIPTION	QTY
1	5.529	Caliper Shaft Housing	1
2	591.08	Caliper Shaft Housing Spring	1
3	591.10	Caliper Shaft Housing Ring	1
4	591.11	Caliper Shaft Housing Wavy Washer	1
5	591.09	Caliper Shaft Housing Washer	1

GTH5.512 Caliper Adjuster Shaft



OEM NO: HDX 90693 - 89926 - SF 3 434 3855 02 - RNLT 5021 174 163

VEHICLE

NR	GTSA KOD	DESCRIPTION	QTY
1	591.04	Caliper Adjuster Shaft	2
2	565.06	Caliper Adjuster Shaft Seal	2
3	565.03	Caliper Head Plug	2

GTH5.574 Caliper Tappet Plate & Bolt Set



OEM NO: HDX 94664

VEHICLE

NR	GTSA KOD	DESCRIPTION	QTY
1	565.02	Caliper Tappet Boot - Ø67 mm	2
2	GTH5.505	Caliper Tappet Plate	1
3	GTH5.506	Caliper Calibration Bolt	2
4	565.03	Caliper Head Plug	1

HDX

MODUL X GEN1 GEN2

GTH5.545 Caliper Tappet Plate & Bolt Set	
	
OEM NO	
VEHICLE	

NR	GTSA KOD	DESCRIPTION	QTY
1	GTH5.505	Caliper Tappet Plate	1
2	591.07	Caliper Tappet Clips	2
3	591.02	Caliper Bolt Clips	2
4	5.506	Caliper Calibration Bolt	2

GTH5.576 Brake Pad Retainer Kit	
	
OEM NO	HDX 94659 - SF 3 434 3851 01 - RNL 5021 174 162 - 5021 174 180
VEHICLE	

NR	GTSA KOD	DESCRIPTION	QTY
1	GTH5.535	Brake Pad Retainer Repair Kit	2
2	591.22	Brake Pad Spring	4
3	565.03	Caliper Head Plug	2

GTH5.575 Brake Pad Retainer Repair Kit	
	
OEM NO	HDX 91216
VEHICLE	

NR	GTSA KOD	DESCRIPTION	QTY
1	GTH5.535	Brake Pad Retainer Repair Kit	1
2	591.22	Brake Pad Spring	2

GTH5.580 Caliper Spring & Plate Set



OEM NO	HDX 92731
VEHICLE	

NR	GTSA KOD	DESCRIPTION	QTY
1	GTH5.505	Caliper Tappet Plate	1
2	591.07	Caliper Tappet Clips	2
3	591.15	Boot Protection Spring - Ø67 mm	2

GTH5.535 Brake Pad Retainer Repair Kit



OEM NO	HDX 90673
VEHICLE	

NR	GTSA KOD	DESCRIPTION	QTY
1	5.535	Brake Pad Retainer Sheet Metal	1
2	555.07	Brake Pad Retainer Bolt - M10x1,50x25 mm	1

GTH5.541 Caliper Protection Spring Set



OEM NO	HDX 94665
VEHICLE	

NR	GTSA KOD	DESCRIPTION	QTY
1	591.15	Boot Protection Spring - Ø67 mm	2
2	591.07	Caliper Tappet Clips	2

HDX

MODUL X GEN1 GEN2

GTH5.579

Caliper Tappet Plate



NR	GTSA KOD	DESCRIPTION	QTY
1	GTH5.505	Caliper Tappet Plate	1
2	591.07	Caliper Tappet Clips	2
3	591.02	Caliper Bolt Clips	2

GTH5.506

Caliper Calibration Bolt Set



NR	GTSA KOD	DESCRIPTION	QTY
1	5.506	Caliper Calibration Bolt	1
2	591.02	Caliper Bolt Clips	1

GTH5.511

Caliper Needle Bearing Set



NR	GTSA KOD	DESCRIPTION	QTY
1	581.02	Caliper Needle Bearing	2

GTH5.531

Caliper Mechanism Plate



OEM NO

VEHICLE

Caliper Lever



OEM NO

VEHICLE

GTH5.533

Caliper Mechanism Cap Set



OEM NO

VEHICLE

GTH5.524 Caliper Intermediate Gear	
	
OEM NO	
VEHICLE	

GTH5.515 Caliper Adjusting Mechanism	
	
OEM NO	
VEHICLE	

GTH5.556 Caliper Lever Pin	
	
OEM NO	
VEHICLE	

GTH5.509 Caliper Adjusting Mechanism Gear	
	
OEM NO	
VEHICLE	

GTH5.510 Caliper Lever Needle Bearing Set	
	
OEM NO	
VEHICLE	

GTH5.559 Caliper Adjusting Mechanism Gear	
	
OEM NO	
VEHICLE	

HDX

MODUL X GEN1 GEN2

GTH5.526 Caliper Adjusting Mechanism	
	
OEM NO	
VEHICLE	

GTH5.530 Caliper Mechanism Clamp	
	
OEM NO	92700
VEHICLE	

GTH5.523 Caliper Adjusting Mechanism Gear	
	
OEM NO	
VEHICLE	

GTH5.525 Caliper Adjusting Mechanism Gear	
	
OEM NO	
VEHICLE	

GTH5.527 Caliper Lever Needle Bearing	
	
OEM NO	
VEHICLE	

GTH5.532 Caliper Lever	
	
OEM NO	
VEHICLE	

All manufacturer names, trademarks, product descriptions contained in this product catalog are for reference only. All reference numbers are for comparison purposes.

GTH5.522 Caliper Tappet & Calibration Bolt



OEM NO	
VEHICLE	

GTH5.560 Caliper Mechanism Clamp - 55 mm



OEM NO	
VEHICLE	

GTH5.528 Caliper Needle Bearing Set



OEM NO	
VEHICLE	

GTH5.536 Caliper Lever Pin



OEM NO	
VEHICLE	

GTH5.533 Caliper Mechanism Cap Set



OEM NO	
VEHICLE	

HDX

MODUL X GEN1 GEN2

SH5005

Caliper Complete Mechanism Set



VEHICLE	SAF Axle - SMB Axle
---------	---------------------

NR	GTSA KOD	DESCRIPTION	QTY
1	GTH5.581	Caliper Pin Repair Kit	1
2	GTH5.557	Caliper Complete Mechanism Set	1
3	GTH5.575	Brake Pad Retainer Repair Kit	1

SH5001

Caliper Complete Mechanism Set



VEHICLE	SAF Axle - SMB Axle - DANA Axle - GIGANT Axle - VOLVO - RENAULT
---------	---

NR	GTSA KOD	DESCRIPTION	QTY
1	GTH5.520	Caliper Pin Repair Kit	1
2	GTH5.534	Caliper Complete Mechanism Set	1
3	GTH5.575	Brake Pad Retainer Repair Kit	1



BV

9.603 Caliper Pin Repair Kit



OEM NO

VEHICLE

NR	GTSA KOD	DESCRIPTION	QTY
1	451.01	Caliper Pin - Ø37x123 mm	1
2	491.03	Caliper Pin Circlip - Ø43x1,50 mm	1
3	451.02	Caliper Pin - Ø36,40x70 mm	1
4	455.01	Caliper Pin Bolt - M16x1,50x100 mm	1
5	155.05.01	Caliper Pin Bolt - M16x1,50x70 mm	1
6	465.04-1	Caliper Pin Plastic Cap	2
7	491.16	Caliper Pin Plastic O-ring	2
8	461.01	Caliper Pin Bush - Ø41xØ37x73 mm	1
9	461.02	Caliper Pin Bush - Ø41xØ37x30 mm	1
10	465.02	Caliper Pin Boot	2
11	491.01	Caliper Pin Boot Ring	2
12	491.02	Caliper Pin Support O-ring - Ø36x3,50 mm	1
13	465.03	Caliper Head Plug	1

9.600 Caliper Pin Repair Kit



OEM NO

VEHICLE

NR	GTSA KOD	DESCRIPTION	QTY
1	451.01	Caliper Pin - Ø37x123 mm	1
2	491.03	Caliper Pin Circlip - Ø43x1,50 mm	1
3	451.02	Caliper Pin - Ø36,40x70 mm	1
4	455.01	Caliper Pin Bolt - M16x1,50x100 mm	1
5	155.05	Caliper Pin Bolt - M16x1,50x70 mm	1
6	491.02	Caliper Pin Support O-ring - Ø36x3,50 mm	1
7	465.04-1	Caliper Pin Plastic Cap	2
8	491.16	Caliper Pin Plastic O-ring	2
9	461.01	Caliper Pin Bush - Ø41xØ37x73 mm	1
10	461.02	Caliper Pin Bush - Ø41xØ37x30 mm	1

9.621 Caliper Mechanism Set - (Flat Tappet)



OEM NO

VEHICLE

NR	GTSA KOD	DESCRIPTION	QTY
1	9.602	Caliper Tappet & Boot Set - (Flat Tappet)	1
2	9.604	Caliper Cover Set	1
3	9.606	Caliper Mechanism Gear Shaft	1
4	9.605	Caliper Mechanism Bearing Slot	1
5	481.01	Caliper Mechanism Bearing	1
6	491.04	Caliper Mechanism Washer	1
7	9.608	Caliper Shaft Housing	1
8	9.617	Caliper Bearing House - (Twain Type)	1
9	9.618	Caliper Mechanism House	1
10	9.611	Caliper Needle Bearing Set	1

9.620 Caliper Mechanism Set - (With Pin Tappet)

OEM NO

VEHICLE

NR	GTSA KOD	DESCRIPTION	QTY
1	9.607	Caliper Tappet & Boot Set - (With Pin Tappet)	1
2	9.604	Caliper Cover Set	1
3	9.606	Caliper Mechanism Gear Shaft	1
4	9.605	Caliper Mechanism Bearing Slot	1
5	481.01	Caliper Mechanism Bearing	1
6	491.04	Caliper Mechanism Washer	1
7	9.608	Caliper Shaft Housing	1
8	9.617	Caliper Bearing House - (Twain Type)	1
9	9.618	Caliper Mechanism House	1
10	9.611	Caliper Needle Bearing Set	1

9.601 Caliper Boot & Pin Bush Set

OEM NO

VEHICLE

NR	GTSA KOD	DESCRIPTION	QTY
1	465.02	Caliper Pin Boot	2
2	491.01	Caliper Pin Boot Ring	2
3	491.02	Caliper Pin Support O-ring - Ø36x3,50 mm	1
4	465.04-1	Caliper Pin Plastic Cap	2
5	491.16	Caliper Pin Plastic O-ring	2
6	461.01	Caliper Pin Bush - Ø41xØ37x73 mm	1
7	461.02	Caliper Pin Bush - Ø41xØ37x30 mm	1
8	465.03	Caliper Head Plug	1

9.632 Caliper Pin & Brake Pad Retainer Repair Kit

OEM NO B 09.801.05.81.0

VEHICLE

NR	GTSA KOD	DESCRIPTION	QTY
1	451.01	Caliper Pin - Ø37x123 mm	1
2	491.03	Caliper Pin Circlip - Ø43x1,50 mm	1
3	451.02	Caliper Pin - Ø36,40x70 mm	1
4	455.01	Caliper Pin Bolt - M16x1,50x100 mm	1
5	155.05	Caliper Pin Bolt - M16x1,50x70 mm	1
6	491.01	Caliper Pin Boot Ring	2
7	9.623	Brake Pad Retainer Repair Kit	1

9.604 Caliper Cover Set



OEM NO B 05.010.95.31.0

VEHICLE

NR	GTSA KOD	DESCRIPTION	QTY
1	4604	Caliper Cover With Mechanism	1
2	455.02	Caliper Cover Bolt - M8x1,25x16 mm	8
3	491.07	Caliper Mechanism Internal Washer	10

9.607 Caliper Tappet & Boot Set - (With Pin Tappet)



OEM NO B 09.801.07.631 - 05.801.50.90.0

VEHICLE

NR	GTSA KOD	DESCRIPTION	QTY
1	468.02	Caliper Tappet - (With Pin)	2
2	465.01	Caliper Tappet Boot	2
3	491.06	Caliper Tappet Locker	2
4	491.05	Caliper Tappet Clamp	2

9.602 Caliper Tappet & Boot Set - (Flat Tappet)



OEM NO B 09.801.07.63.0

VEHICLE

NR	GTSA KOD	DESCRIPTION	QTY
1	468.01	Caliper Tappet - (Flat)	2
2	465.01	Caliper Tappet Boot	2
3	491.06	Caliper Tappet Locker	2
4	491.05	Caliper Tappet Clamp	2

9.609	Caliper Lever Set
	
OEM NO	
VEHICLE	

NR	GTSA KOD	DESCRIPTION	QTY
1	9.609-3	Caliper Lever	1
2	9.609-1	Caliper Lever Pin	1
3	491.09	Caliper Lever Pin Washer	1
4	455.02	Caliper Lever Pin Bolt - M8x1,25x16 mm	1

9.619	Caliper Adjuster Shaft Set
	
OEM NO	
VEHICLE	

NR	GTSA KOD	DESCRIPTION	QTY
1	491.24	Caliper Adjuster Shaft	1
2	4.619-2	Caliper Adjuster Shaft Spring	1
3	491.19	Caliper Adjuster Shaft Seal	1
4	491.25	Caliper Adjuster Shaft Washer	1
5	491.23	Caliper Adjuster Shaft Bush	1
6	4.619-1	Caliper Adjuster Shaft Ring	1

9.620-1	Caliper Mechanism Set - (With Pin Tappet) New Model
	
OEM NO	
VEHICLE	

NR	GTSA KOD	DESCRIPTION	QTY
1	9.607	Caliper Tappet & Boot Set - (With Pin Tappet)	1
2	9.604	Caliper Cover Set	1
3	9.606	Caliper Mechanism Gear Shaft	1
4	9.605	Caliper Mechanism Bearing Slot	1
5	481.01	Caliper Mechanism Bearing	1
6	491.04	Caliper Mechanism Washer	1
7	9.608	Caliper Shaft Housing	1
8	9.624	Caliper Bearing House - (Monoblock Type)	1

9.621-1



NR	GTSA KOD	DESCRIPTION	QTY
1	9.621	Caliper Mechanism Set - (Flat Tappet)	1
2	9.609	Caliper Lever Set	1
3	9.610	Caliper Needle Bearing Set	1

9.628-1

Caliper Complete Mechanism Set - (With Pin Tappet)
New Model



NR	GTSA KOD	DESCRIPTION	QTY
1	9.620-1	Caliper Mechanism Set - (With Pin Tappet)	1
2	9.609	Caliper Lever Set	1
3	9.610	Caliper Needle Bearing Set	1

9.628

Caliper Complete Mechanism Set - (With Pin Tappet)



NR	GTSA KOD	DESCRIPTION	QTY
1	9.620	Caliper Mechanism Set - (With Pin Tappet)	1
2	9.609	Caliper Lever Set	1
3	9.610	Caliper Needle Bearing Set	1

9.623

Brake Pad Retainer Repair Kit



OEM NO	B 03.001.00.54.C
VEHICLE	

9.608

Caliper Shaft Housing



OEM NO	
VEHICLE	

9.616

Brake Pad Spring Set - Tall



OEM NO	
VEHICLE	

BV



NR	GTSA KOD	DESCRIPTION	QTY
1	481.02	Caliper Needle Bearing	2



NR	GTSA KOD	DESCRIPTION	QTY
1	471.01	Caliper Plug	5



NR	GTSA KOD	DESCRIPTION	QTY
1	491.04	Caliper Mechanism Washer	5



NR	GTSA KOD	DESCRIPTION	QTY
1	491.07	Caliper Mechanism Internal Washer	10



NR	GTSA KOD	DESCRIPTION	QTY
1	481.01	Caliper Mechanism Bearing	10



OEM NO	VEHICLE

9.615 Brake Pad Spring Set - Short



OEM NO	
VEHICLE	

9.617 Caliper Bearing House - (Twain Type)



OEM NO	
VEHICLE	

9.618 Caliper Mechanism House



OEM NO	B 01:127.38.02.0
VEHICLE	

9.611 Caliper Needle Bearing Set



OEM NO	
VEHICLE	

9.606 Caliper Mechanism Gear Shaft



OEM NO	
VEHICLE	

9.605 Caliper Mechanism Bearing Slot



OEM NO	
VEHICLE	

9002 Caliper Complete Repair Kit - (With Pin Tappet)



NR	GTSA KOD	DESCRIPTION	QTY
1	9.603	Caliper Pin Repair Kit	1
2	9.628	Caliper Complete Mechanism Set - (With Pin Tappet)	1
3	9.619	Caliper Adjuster Shaft Set	1
4	471.01	Caliper Plug	2

9001-1 Caliper Complete Repair Kit - (With Pin Tappet) New Model



NR	GTSA KOD	DESCRIPTION	QTY
1	9.603	Caliper Pin Repair Kit	1
2	9.628-1	Caliper Complete Mechanism Set - (With Pin Tappet) New Model	1
3	9.619	Caliper Adjuster Shaft Set	1
4	471.01	Caliper Plug	2

9003 Caliper Complete Repair Kit - (Flat Tappet)



NR	GTSA KOD	DESCRIPTION	QTY
1	9.603	Caliper Pin Repair Kit	1
2	9.621-1	Caliper Complete Mechanism Set - (Flat Tappet)	1
3	9.619	Caliper Adjuster Shaft Set	1
4	9.623	Brake Pad Retainer Repair Kit	1
5	471.01	Caliper Plug	2



SF

GTS6.400 Caliper Pin Repair Kit



OEM NO SF 3 434 3861 00 - HDX 95397

VEHICLE SAF Axle

NR	GTSA KOD	DESCRIPTION	QTY
1	651.02	Caliper Pin - Ø35x118,70 mm	1
2	651.01	Caliper Pin - Ø35,50x86,75 mm	1
3	155.01	Caliper Pin Bolt - M16x1,50x80 mm	2
4	261.01	Caliper Pin Bush - Ø39xØ35x30 mm	2
5	675.01	Caliper Pin Bush - Ø39,50xØ36x14,50 mm	1
6	665.08	Caliper Pin Composite Bush - Ø35,70xØ35,40x87 mm	1
7	665.07	Caliper Pin Boot	2
8	691.02	Caliper Pin Boot Ring	2
9	671.02	Caliper Pin Cap - Ø45x22,50 mm	1
10	671.01	Caliper Pin Cap - Ø42x25 mm	1

GTS6.420 Caliper Complete Mechanism Set



OEM NO

VEHICLE SAF Axle

NR	GTSA KOD	DESCRIPTION	QTY
1	GTS6.419	Caliper Lever	1
2	GTS6.417	Caliper Bearing Set	1
3	GTS6.414	Caliper Needle Bearing Set	1
4	GTS6.404	Caliper Lever Housing	1
5	GTS6.402	Caliper Mechanism Gear Shaft	1
6	GTS6.413	Caliper Shaft Housing	1
7	GTS6.403	Caliper Adjusting Mechanism	1
8	665.06	Caliper Mechanism Locker	1
9	665.01	Caliper Adjustment Screw Bellow	1

GTS6.410 Caliper Mechanism Bearing Set



OEM NO

VEHICLE

NR	GTSA KOD	DESCRIPTION	QTY
1	681.04	Caliper Mechanism Thrust Bearing	1
2	681.03	Caliper Mechanism Thrust Bearing	1
3	681.02	Caliper Mechanism Thrust Bearing	1
4	681.01	Caliper Mechanism Vertical Bearing	1

SF MODUL T

GTS6.424 Caliper Reset Shaft Kit	
	
OEM NO	SF 3 434 3862 00 - HDX 95398
VEHICLE	

NR	GTSA KOD	DESCRIPTION	QTY
1	665.05	Caliper Reset Shaft	1
2	691.01	Caliper Reset Shaft O-ring	1
3	665.03	Caliper Reset Shaft Plug	1

GTS6.421 Caliper Reset Shaft Kit	
	
OEM NO	
VEHICLE	

NR	GTSA KOD	DESCRIPTION	QTY
1	665.05	Caliper Reset Shaft	1
2	691.01	Caliper Reset Shaft O-ring	1
3	665.04	Caliper Reset Shaft Gear	1
4	665.03	Caliper Reset Shaft Plug	1

GTS6.423 Caliper Mechanism Seal Kit	
	
OEM NO	SF 3 434 3863 00 - HDX 95399
VEHICLE	

NR	GTSA KOD	DESCRIPTION	QTY
1	665.01	Caliper Adjustment Screw Bellow	1
2	665.03	Caliper Reset Shaft Plug	1

GTS6.418 Brake Pad Retainer Repair Kit



OEM NO	
VEHICLE	

NR	GTSA KOD	DESCRIPTION	QTY
1	691.04	Brake Pad Retainer Sheet Metal	1
2	691.05	Brake Pad Retainer Sheet Metal Spring	1

GTS6.406 Caliper Reset Shaft Gear Set



OEM NO	HDX 94700
VEHICLE	

NR	GTSA KOD	DESCRIPTION	QTY
1	665.04	Caliper Reset Shaft Gear	5

GTS6.409 Caliper Mechanism Locker Set



OEM NO	HDX 95535
VEHICLE	

NR	GTSA KOD	DESCRIPTION	QTY
1	665.06	Caliper Mechanism Locker	5

SF MODUL T

GTS6.417

Caliper Bearing Set



OEM NO

VEHICLE

NR	G TSA KOD	DESCRIPTION	QTY
1	GTS6.415	Caliper Needle Bearing Set	1
2	681.07	Caliper Lever Roller Bearing	2

GTS6.412

Caliper Mechanism Bearing House Set



OEM NO

VEHICLE

NR	G TSA KOD	DESCRIPTION	QTY
1	6.403-13	Caliper Mechanism Bearing House	5

GTS6.401

Caliper Reset Shaft Set



NR

G TSA KOD

DESCRIPTION

QTY

1 665.05 Caliper Reset Shaft 5

2 691.01 Caliper Reset Shaft O-ring 5

GTS6.405

Caliper Adjustment Screw Bellow Set



NR

G TSA KOD

DESCRIPTION

QTY

1 665.01 Caliper Adjustment Screw Bellow 1

GTS6.425 Caliper Mechanism Protection Cap Set



NR	GTSA KOD	DESCRIPTION	QTY
1	665.11	Caliper Mechanism Protection Cap	5

GTS6.408 Caliper Reset Shaft Plug



NR	GTSA KOD	DESCRIPTION	QTY
1	665.03	Caliper Reset Shaft Plug	5

GTS6.407 Caliper Protection Plug Set



NR	GTSA KOD	DESCRIPTION	QTY
1	665.02	Caliper Protection Plug	5

GTS6.404 Caliper Lever Housing



OEM NO	
VEHICLE	

GTS6.414 Caliper Needle Bearing Set



OEM NO	
VEHICLE	

GTS6.402 Caliper Mechanism Gear Shaft



OEM NO	
VEHICLE	

SF MODUL T

GTS6.413 Caliper Shaft Housing



OEM NO

VEHICLE

GTS6.403 Caliper Adjusting Mechanism



OEM NO

VEHICLE

GTS6.419 Caliper Lever



OEM NO

VEHICLE

GTS6.415 Caliper Needle Bearing Set



OEM NO

VEHICLE

SS6001 Caliper Complete Repair Kit



VEHICLE

NR	GTSA KOD	DESCRIPTION	QTY
1	GTS6.400	Caliper Pin Repair Kit	1
2	GTS6.420	Caliper Complete Mechanism Set	1
3	GTS6.421	Caliper Reset Shaft Kit	1

All manufacturer names, trademarks, product descriptions contained in this product catalog are for reference only. All reference numbers are for comparison purposes.



IVC

GTI7.389

Brake Adjuster Repair Kit - Thin Teeth



OEM NO

RBSK0502B.M

VEHICLE

NR	GTSA KOD	DESCRIPTION	QTY
1	GTI7.383	Brake Adjusting Guide Pawl (Thin Teeth) - 19 mm	2
2	GTI7.374	Brake Adjusting Actuator (Thin Teeth)	2
3	GTI7.378	Brake Adjusting Plunger-Ø34,90 mm	2
4	GTI7.373	Brake Adjusting Bolt	2
5	GTI7.375	Brake Adjusting Plunger Seal	2
6	GTI7.377	Brake Shoe Return Spring	2

GTI7.398

Brake Adjusting Plunger Seal Set



OEM NO

IVECO 7980408 - MRT RBSK0251B.M - BRDMN RNBS 192757 - ZF 0501298164

VEHICLE

NR	GTSA KOD	DESCRIPTION	QTY
1	GTI7.375	Brake Adjusting Plunger Seal	4
2	GTI7.376	Brake Anchor Plunger Seal	4

GTI7.391

Brake Anchor Plunger Set - L



OEM NO

IVECO 7980405 - MRT RBSK0248B.M - BRDMN RNBS 192754 - AWD A4023357

VEHICLE

NR	GTSA KOD	DESCRIPTION	QTY
1	GTI7.384	Brake Adjusting Guide Screw - 19 mm	2
2	GTI7.379	Brake Anchor Plunger - Ø34,90 mm - L	2
3	GTI7.376	Brake Anchor Plunger Seal	2

IVC

Ø381/394 DUPLEX

GTI7.390

Brake Anchor Plunger Set - R



OEM NO

IVECO 7980406 - MRT RBSK0248B.M - BRDMNRNBS 192755 - VNHL 10610921

VEHICLE

NR	GTSA KOD	DESCRIPTION	QTY
1	GTI7.384	Brake Adjusting Guide Screw - 19 mm	2
2	GTI7.380	Brake Anchor Plunger - Ø34,90 mm - R	2
3	GTI7.376	Brake Anchor Plunger Seal	2

GTI7.399

Brake Adjuster Repair Kit



OEM NO

IVECO 42491974 - MRT RBSK0549B.M - VLV 272857 - BRDMNRNBS 192752 - VNHL 634321204

VEHICLE

NR	GTSA KOD	DESCRIPTION	QTY
1	GTI7.383	Brake Adjusting Guide Pawl (Thin Teeth) - 19 mm	2
2	GTI7.374	Brake Adjusting Actuator (Thin Teeth)	2
3	GTI7.378	Brake Adjusting Plunger-Ø34,90 mm	2

GTI7.3001

Brake Wedge Set



OEM NO

7980407 - A2247U47 - RBSK0250B.M

VEHICLE

NR	GTSA KOD	DESCRIPTION	QTY
1	GTI7.381	Brake Wedge	2

GTI7.382 Brake Wedge	
	
OEM NO	
VEHICLE	

GTI7.381 Brake Wedge	
	
OEM NO	IVECO 7980407 - 93161353 - 42480062 - MRT RBSKO250B.M - BRDMNRRNBS 192756 - ZF 0501298159 - AWD A4022499 - A2247U47 - A2247D1018
VEHICLE	

GTI7.388 Brake Collet Nut - LONG	
	
OEM NO	165005
VEHICLE	

GTI7.373 Brake Adjusting Bolt	
	
OEM NO	IVECO 42480059 - MRT A164002 - A2297L3158 - VLV 1696537 - NSSN 69028770 - PCCR Y07088205 - VNHL 634321222
VEHICLE	

GTI7.385 Brake Hold-Down Clip	
	
OEM NO	IVECO 42488484 - MRT 2257D108 - 2257M1001 - VLV 6770266 - NSSN 69028800 - PCCR Y03018809 - VNHL 634321233 - FRD 82DB-2B026AA
VEHICLE	

GTI7.386 Brake Collet Nut - SHORT	
	
OEM NO	165017
VEHICLE	

IVC

Ø410 DUPLEX

GTI7.3002 Brake Adjuster Repair Kit - Thick Teeth (New Model)



OEM NO IVECO 42562830 - 42559512

VEHICLE

NR	GTSA KOD	DESCRIPTION	QTY
1	GTI7.324	Brake Adjusting Guide Pawl (Thick Teeth) - 22 mm	2
2	GTI7.322	Brake Adjusting Actuator (Thick Teeth)	2
3	GTI7.323	Brake Adjusting Plunger - Ø38,50 mm	2
4	GTI7.331	Brake Adjusting Bolt	2
5	GTI7.301	Brake Adjusting Plunger Seal	2
6	GTI7.330	Brake Shoe Return Spring (Thick)	2

GTI7.3003 Brake Adjuster Repair Kit - Thick Teeth (Old Model)



OEM NO IVECO 42536197 - 42558432

VEHICLE

NR	GTSA KOD	DESCRIPTION	QTY
1	GTI7.324	Brake Adjusting Guide Pawl (Thick Teeth) - 22 mm	2
2	GTI7.322	Brake Adjusting Actuator (Thick Teeth)	2
3	GTI7.323	Brake Adjusting Plunger - Ø38,50 mm	2
4	GTI7.300	Brake Adjusting Bolt	2
5	GTI7.301	Brake Adjusting Plunger Seal	2
6	GTI7.330	Brake Shoe Return Spring (Thick)	2

GTI7.336 Brake Adjuster Repair Kit - Thick Teeth (New Model)



OEM NO IVECO 2996557

VEHICLE

NR	GTSA KOD	DESCRIPTION	QTY
1	GTI7.324	Brake Adjusting Guide Pawl (Thick Teeth) - 22 mm	4
2	GTI7.322	Brake Adjusting Actuator (Thick Teeth)	4
3	GTI7.331	Brake Adjusting Bolt	4
4	GTI7.301	Brake Adjusting Plunger Seal	4

GTI7.3004 Brake Adjusting Plunger Seal Set



OEM NO IVECO 93161625

VEHICLE

NR	G TSA KOD	DESCRIPTION	QTY
1	GTI7.301	Brake Adjusting Plunger Seal	4

GTI7.3005 Brake Adjusting Plunger Seal Set



OEM NO IVECO 42537884

VEHICLE

NR	G TSA KOD	DESCRIPTION	QTY
1	GTI7.301	Brake Adjusting Plunger Seal	4
2	GTI7.321	Brake Anchor Plunger Seal	4

GTI7.335 Brake Adjuster Repair Kit - Thick Teeth



OEM NO

VEHICLE

NR	G TSA KOD	DESCRIPTION	QTY
1	GTI7.324	Brake Adjusting Guide Pawl (Thick Teeth) - 22 mm	1
2	GTI7.322	Brake Adjusting Actuator (Thick Teeth)	1
3	GTI7.323	Brake Adjusting Plunger - Ø38,50 mm	1

IVC

Ø410 DUPLEX

GTI7.334 Brake Anchor Plunger Set - L (New Model)



OEM NO IVECO - 42537364 - 42537366 - MRT RBSK1600.M - RBSK1607.M

VEHICLE

NR	GTSA KOD	DESCRIPTION	QTY
1	GTI7.325	Brake Adjusting Guide Screw - 22 mm	2
2	GTI7.326	Brake Anchor Plunger - Ø38,50 mm - L	2
3	GTI7.321	Brake Anchor Plunger Seal	2

GTI7.333 Brake Anchor Plunger Set - R (New Model)



OEM NO IVECO 42537363 - 42537365 - MRT RBSK1599.M - RBSK1606.M

VEHICLE

NR	GTSA KOD	DESCRIPTION	QTY
1	GTI7.325	Brake Adjusting Guide Screw - 22 mm	2
2	GTI7.327	Brake Anchor Plunger - Ø38,50 mm - R	2
3	GTI7.321	Brake Anchor Plunger Seal	2

GTI7.3007 Brake Shoe Return Spring Kit (Thin)



OEM NO RBSK1586.M

VEHICLE

NR	GTSA KOD	DESCRIPTION	QTY
1	GTI7.3006	Brake Shoe Return Spring	4

GT17.312	Brake Collet Nut - LONG
	
OEM NO	1227K1337
VEHICLE	

GT17.310	Brake Wedge
	
OEM NO	IVECO 42536194 - 42537942 - 93161621 - MRT RBSK1255.M - RB-SK1573.M - RBSK2051.M - DF 1258802 - A2247L1000
VEHICLE	

GT17.3006	Brake Shoe Return Spring (Thin)
	
OEM NO	MRT 2258Y1507 - FRD 6C462L371AA
VEHICLE	

GT17.330	Brake Shoe Return Spring (Thick)
	
OEM NO	6C462L371AA
VEHICLE	

IVC

Ø410 SIMPLEX

GTI7.314 Brake Adjuster Repair Kit - Thin Teeth



OEM NO IVECO 42558430 - 93161622 - 93162114 - MRT RBSK1408.M

VEHICLE

NR	GTSA KOD	DESCRIPTION	QTY
1	GTI7.311	Brake Adjusting Guide Pawl (Thin Teeth) - 22 mm	2
2	GTI7.302	Brake Adjusting Actuator (Thin Teeth)	2
3	GTI7.303	Brake Adjusting Plunger - Ø38,50 mm	2
4	GTI7.300	Brake Adjusting Plunger - Ø38,50 mm	2
5	GTI7.301	Brake Adjusting Plunger Seal	2
6	GTI7.308	Brake Shoe Return Spring	1
7	GTI7.309	Brake Shoe Return Spring (Thin)	1

GTI7.372 Brake Adjuster Repair Kit - Thick Teeth



OEM NO

VEHICLE

NR	GTSA KOD	DESCRIPTION	QTY
1	GTI7.324	Brake Adjusting Guide Pawl (Thick Teeth) - 22 mm	2
2	GTI7.3008	Brake Adjusting Actuator (Thick Teeth)	2
3	GTI7.3009	Brake Adjusting Plunger	2
4	GTI7.3010	Brake Adjusting Bolt	2
5	GTI7.301	Brake Adjusting Plunger Seal	2
6	GTI7.3011	Brake Shoe Return Spring	1
7	GTI7.3012	Brake Shoe Return Spring	1

GTI7.319 Brake Adjuster Repair Kit - Thin Teeth



OEM NO

VEHICLE

NR	GTSA KOD	DESCRIPTION	QTY
1	GTI7.311	Brake Adjusting Guide Pawl (Thin Teeth) - 22 mm	4
2	GTI7.302	Brake Adjusting Actuator (Thin Teeth)	4
3	GTI7.300	Brake Adjusting Bolt	4
4	GTI7.301	Brake Adjusting Plunger Seal	4

GTI7.318 Brake Adjuster Repair Kit - Thin Teeth



OEM NO	RBSK1407.M
VEHICLE	

NR	G TSA KOD	DESCRIPTION	QTY
1	GTI7.311	Brake Adjusting Guide Pawl (Thin Teeth) - 22 mm	1
2	GTI7.302	Brake Adjusting Actuator (Thin Teeth)	1
3	GTI7.303	Brake Adjusting Plunger - Ø38,50 mm	1

GTI7.310 Brake Wedge



OEM NO	IVECO 42536194 - 42537942 - 93161621 - MRT RBSK1255.M - RB-SK1573.M - RBSK2051.M - DF 1258802 - A2247L1000
VEHICLE	

NR	G TSA KOD	DESCRIPTION	QTY
1	GTI7.310	Brake Wedge	2

GTI7.317 Brake Anchor Plunger Kit - R



OEM NO	IVECO 93161864 - MRT RBSK1482.M
VEHICLE	

NR	G TSA KOD	DESCRIPTION	QTY
1	GTI7.307	Brake Anchor Plunger - Angle 5° - R	1
2	GTI7.306	Brake Anchor Plunger - Angle 15° - R	1

IVC

Ø410 SIMPLEX

GTI7.3014

Brake Shoe Return Spring Kit



OEM NO

IVECO 93161627 - 93162113

VEHICLE

NR	G TSA KOD	DESCRIPTION	QTY
1	GTI7.308	Brake Shoe Return Spring	2
2	GTI7.309	Brake Shoe Return Spring (Thin)	2

GTI7.316

Brake Anchor Plunger Kit - L



OEM NO

IVECO 93161863 - MRT RBSK1481.M

VEHICLE

NR	G TSA KOD	DESCRIPTION	QTY
1	GTI7.305	Brake Anchor Plunger - Angle 5° - L	1
2	GTI7.304	Brake Anchor Plunger - Angle 15° - L	1

GTI7.312

Brake Collet Nut - LONG



OEM NO

1227K1337

VEHICLE

GTI7.305

Brake Anchor Plunger - Angle 5° - L



OEM NO

IVECO 93161863 -1259A1015

VEHICLE

GTI7.306 Brake Anchor Plunger - Angle 15° - R	
	
OEM NO	
VEHICLE	

GTI7.309 Brake Shoe Return Spring (Thin)	
	
OEM NO	MRT 2258F1306
VEHICLE	

GTI7.313 Brake Hold-Down Clip	
	
OEM NO	225781004
VEHICLE	

GTI7.307 Brake Anchor Plunger - Angle 5° - R	
	
OEM NO	IVECO 93161864 - 1259Z1014
VEHICLE	

GTI7.308 Brake Shoe Return Spring	
	
OEM NO	MRT 2258D1122
VEHICLE	

GTI7.304 Brake Anchor Plunger - Angle 15° - L	
	
OEM NO	IVECO 93161863
VEHICLE	

IVC

Ø360 PERROT

GTI7.365 Brake Adjuster Repair Kit	
	
OEM NO	
VEHICLE	

NR	G TSA KOD	DESCRIPTION	QTY
1	GTI7.347	Brake Adjusting Guide Pawl	2
2	GTI7.356	Brake Adjusting Plunger - Ø41,50x49,00 mm	2
3	GTI7.355	Brake Adjusting Actuator Upper - Ø36x21,50 mm	2
4	GTI7.360	Brake Adjusting Actuator Lower - Ø32x18,30 mm	2
5	GTI7.338	Brake Adjusting Bolt	2
6	GTI7.344	Brake Adjusting Plunger Seal	2
7	GTI7.343	Brake Adjusting Washer	2
8	GTI7.343	Brake Adjusting Ring	

GTI7.354 Brake Adjuster Repair Kit	
	
OEM NO	
VEHICLE	

NR	G TSA KOD	DESCRIPTION	QTY
1	GTI7.356	Brake Adjusting Plunger - Ø41,50x49,00 mm	1
2	GTI7.355	Brake Adjusting Actuator Upper - Ø36x21,50 mm	1
3	GTI7.360	Brake Adjusting Actuator Lower - Ø32x18,30 mm	1
4	GTI7.338	Brake Adjusting Bolt	1
5	GTI7.343	Brake Adjusting Washer	1
6	GTI7.343	Brake Adjusting Ring	1

GTI7.353 Brake Adjuster Repair Kit	
	
OEM NO	12 999 418VT - 93161254
VEHICLE	

NR	G TSA KOD	DESCRIPTION	QTY
1	GTI7.338	Brake Adjusting Bolt	2
2	GTI7.344	Brake Adjusting Plunger Seal	2
3	GTI7.343	Brake Adjusting Washer	2
4	GTI7.343	Brake Adjusting Ring	2

GTI7.363 Brake Adjuster Complete Repair Kit



OEM NO

VEHICLE

NR	G TSA KOD	DESCRIPTION	QTY
1	GTI7.365	Brake Adjuster Repair Kit	1
2	GTI7.357	Brake Wedge	1
3	GTI7.345	Brake Shoe Return Spring	1
4	GTI7.358	Brake Shoe Return Spring	1

GTI7.364 Brake Adjuster Repair Kit (Long)



OEM NO 12 999 403VT

VEHICLE

NR	G TSA KOD	DESCRIPTION	QTY
1	GTI7.347	Brake Adjusting Guide Pawl	2
2	GTI7.355	Brake Adjusting Actuator Upper - Ø36x21,50 mm	2
3	GTI7.360	Brake Adjusting Actuator Lower - Ø32x18,30 mm	2

GTI7.361 Brake Adjuster Repair Kit (Short)



OEM NO 12 999 135VT

VEHICLE

NR	G TSA KOD	DESCRIPTION	QTY
1	GTI7.347	Brake Adjusting Guide Pawl	2
2	GTI7.359	Brake Adjusting Actuator Upper - Ø36x18,50 mm	2
3	GTI7.360	Brake Adjusting Actuator Lower - Ø32x18,30 mm	2

IVC

Ø360 PERROT

GTI7.362 Brake Wedge Set	
OEM NO	12 999 402VT
VEHICLE	

NR	GTSA KOD	DESCRIPTION	QTY
1	GTI7.356	Brake Adjusting Plunger - Ø41,50x49,00 mm	2
2	GTI7.357	Brake Wedge	1

GTI7.3015 Brake Shoe Return Spring Kit	
OEM NO	
VEHICLE	

NR	GTSA KOD	DESCRIPTION	QTY
1	GTI7.358	Brake Shoe Return Spring	4
2	GTI7.3013	Brake Hold-Down Clip	4

GTI7.3013 Brake Hold-Down Clip	
OEM NO	
VEHICLE	

GTI7.345 Brake Shoe Return Spring	
OEM NO	13 301 191
VEHICLE	

GT17.358

Brake Shoe Return Spring



OEM NO

13 301 212

VEHICLE

GT17.357

Brake Wedge



OEM NO

VEHICLE

IVC

Ø410 PERROT

GTI7.351 Brake Adjuster Repair Kit	
	
OEM NO	IVECO 93161256 - DF 1505884 - WBC 12 999 411VT
VEHICLE	

NR	G TSA KOD	DESCRIPTION	QTY
1	GTI7.347	Brake Adjusting Guide Pawl	2
2	GTI7.340	Brake Adjusting Plunger - Ø43,90x61,00 mm	2
3	GTI7.339	Brake Adjusting Actuator Upper - Ø38x21,50 mm	2
4	GTI7.360	Brake Adjusting Actuator Lower - Ø32x18,30 mm	2
5	GTI7.338	Brake Adjusting Bolt	2
6	GTI7.344	Brake Adjusting Plunger Seal	2
7	GTI7.343	Brake Adjusting Washer	2
8	GTI7.343	Brake Adjusting Ring	2

GTI7.337 Brake Adjuster Repair Kit	
	
OEM NO	
VEHICLE	

NR	G TSA KOD	DESCRIPTION	QTY
1	GTI7.340	Brake Adjusting Plunger - Ø43,90x61,00 mm	2
2	GTI7.339	Brake Adjusting Actuator Upper - Ø38x21,50 mm	2
3	GTI7.360	Brake Adjusting Actuator Lower - Ø32x18,30 mm	2
4	GTI7.338	Brake Adjusting Bolt	2
5	GTI7.343	Brake Adjusting Washer	2
6	GTI7.343	Brake Adjusting Ring	2

GTI7.350 Brake Adjuster Complete Repair Kit	
	
OEM NO	
VEHICLE	

NR	G TSA KOD	DESCRIPTION	QTY
1	GTI7.351	Brake Adjuster Repair Kit	1
2	GTI7.342	Brake Wedge	1
3	GTI7.345	Brake Shoe Return Spring	1
4	GTI7.346	Brake Shoe Return Spring	1

GTI7.352 Brake Adjuster Repair Kit



OEM NO	IVECO 93161257 - 12 999 404VT
VEHICLE	

NR	G TSA KOD	DESCRIPTION	QTY
1	GTI7.344	Brake Adjusting Plunger Seal	2
2	GTI7.343	Brake Adjusting Washer	2
3	GTI7.343	Brake Adjusting Ring	2

GTI7.348 Brake Adjuster Repair Kit



OEM NO	12 999 411VT
VEHICLE	

NR	G TSA KOD	DESCRIPTION	QTY
1	GTI7.347	Brake Adjusting Guide Pawl	2
2	GTI7.339	Brake Adjusting Actuator Upper - Ø38x21,50 mm	2
3	GTI7.360	Brake Adjusting Actuator Lower - Ø32x18,30 mm	2

GTI7.395 Brake Shoe Return Spring Kit



OEM NO	
VEHICLE	

NR	G TSA KOD	DESCRIPTION	QTY
1	GTI7.345	Brake Shoe Return Spring	2
2	GTI7.346	Brake Shoe Return Spring	2
3	GTI7.3013	Brake Hold-Down Clip	4

IVC

Ø410 PERROT

GTI7.349 Brake Wedge Set	
	
OEM NO	IVECO 1518475 - 93161267 - 12 999 410VT
VEHICLE	

NR	GTSA KOD	DESCRIPTION	QTY
1	GTI7.340	Brake Adjusting Plunger - Ø43,90x61,00 mm	2
2	GTI7.342	Brake Wedge	1

GTI7.342 Brake Wedge	
	
OEM NO	
VEHICLE	

GTI7.346 Brake Shoe Return Spring	
	
OEM NO	
VEHICLE	

GTI7.345 Brake Shoe Return Spring	
	
OEM NO	13 301 191
VEHICLE	

GTI7.3013 Brake Hold-Down Clip	
	
OEM NO	
VEHICLE	



Z-CM

GTZ8.205 Brake Adjuster Shaft - L	
	
OEM NO	1892003407231 - 1694352 - A164061 - ST4014 - ST4023
VEHICLE	

GTZ8.207 Brake Pinion (Long) - R (New Model)	
	
OEM NO	3346449R1 - MB 89200340794 - MN 1350890 - DF 1694794
VEHICLE	

GTZ8.204 Brake Adjuster Shaft - R	
	
OEM NO	3348784R91 - 1472809 - 8603390 - N2509996054
VEHICLE	

GTZ8.234 Brake Pinion (Long) - L (Old Model)	
	
OEM NO	1696924 - DF 1694793- IVECO 3346448R1 - MB 89200340793
VEHICLE	

GTZ8.206 Brake Pinion (Long) - L (New)	
	
OEM NO	89200340793 - 1892003407931 - MN 1350884 - 8605966 - 1694793
VEHICLE	

GTZ8.235 Brake Pinion (Long) - R (Old Model)	
	
OEM NO	1696925 - 1694794 - MB 89200340794 - 1892003407941
VEHICLE	

Z-CM

GTZ8.210 Brake Manual Adjuster (Long) - L (New Model)



OEM NO 1606775 - MRT 68020145 - RNLT 5006 046 765 -ST1038

VEHICLE

GTZ8.237 Brake Manual Adjuster (Long) - R (Old Model)



OEM NO 1081820 - 3090998 - MRT ST1039 - MN 1428758 - N2509996051

VEHICLE

GTZ8.209 Brake Manual Adjuster (Long) - R (New Model)



OEM NO 1607502 - MRT 68020146 - RNLT 5006 046 766 - ST1039

VEHICLE

GTZ8.238 Brake Manual Override Kit - L (Old Model)



OEM NO SP8548

VEHICLE

GTZ8.236 Brake Manual Adjuster (Long) - L (Old Model)



OEM NO 1081819 - 3090997 - MRT ST1038 - MN 1428741

VEHICLE

GTZ8.239 Brake Manual Override Kit - R (Old Model)



OEM NO SP8549

VEHICLE

GTZ8.208	Brake Cross Shaft Assembly
	
OEM NO	272910 - 1696453 - 1694368 - 3098271 - MB 1892003407351
VEHICLE	

GTZ8.223	Brake Manual Override Stem Kit (New Model) (Wide Teeth)
	
OEM NO	276099 - MN 2068777 - 8604735 - 85.500.013.424 - MRT ST1034
VEHICLE	

GTZ8.230	Brake Manual Override Stem Kit (Old Model)
	
OEM NO	276096 - MN 1449350 - MRT ST1033 - PCCR TP02006268
VEHICLE	

GTZ8.225	Brake Abutment Pin
	
OEM NO	1696445 - 1698346 - 3097299 - MRT 68192487 - 68200150 - 137075
VEHICLE	

GTZ8.222	Brake Manual Override Stem Kit (New Model) (Thin Teeth)
	
OEM NO	276100 - 1694364 - 3090964 - 3098275
VEHICLE	

GTZ8.211	Brake Adjuster Strut
	
OEM NO	1696446 - 1694355 - MB 1892003407251 - MN 8603393 - N2970060001
VEHICLE	

GTZ8.213 Brake Cover Plate Gasket	
	
OEM NO	1696450 - DF 1694348 - MN 1321234 - 8603385
VEHICLE	

GTZ8.224 Brake Cover Plate Seal Kit	
	
OEM NO	ST1053 - ST4025
VEHICLE	

GTZ8.212 Brake Cover Plate	
	
OEM NO	1696449 - 1694347 - IVECO 3346423R1 - MN 1321228
VEHICLE	

GTZ8.219 Brake Adjuster Lock Kit - L	
	
OEM NO	276097 - 3098274 - 1694365 - MN 1336762
VEHICLE	

GTZ8.218 Brake Adjuster Lock Kit - R	
	
OEM NO	276098 - 3098273 - 1694366 - IVECO 3346441R91
VEHICLE	

GTZ8.214 Brake Adjuster C Spring	
	
OEM NO	1696444 - 694362 - 3097092 - IVECO 3346437R1 - MB 1892003407951
VEHICLE	

GTZ8.215

Brake Adjuster Dirt Excluder



OEM NO 1696448 - 1694354 - 3090954 - IVECO 42540274 - MB 89200340815

VEHICLE

GTZ8.216

Brake Adjuster Stem



OEM NO IVECO 3346433R1 - MN 1336791 - N2509990127 - MRT 68191930

VEHICLE

SZ8002 Brake Adjuster Complete Repair Kit - L



VEHICLE VOLVO F10/F12/F16 - VOLVO FL10/FL12 - VOLVO BUS B10B/B10L/B12

NR	GTSA KOD	DESCRIPTION	QTY
1	GTZ8.214	Brake Adjuster C Spring	1
2	GTZ8.205	Brake Adjuster Shaft - L	1
3	GTZ8.204	Brake Adjuster Shaft - R	1
4	GTZ8.208	Brake Cross Shaft Assembly	1
5	GTZ8.215	Brake Adjuster Dirt Excluder	2

NR	GTSA KOD	DESCRIPTION	QTY
6	GTZ8.211	Brake Adjuster Strut	2
7	GTZ8.224	Brake Cover Plate Seal Kit	1
8	GTZ8.238	Brake Manual Override Kit - L (Old Model)	1
9	GTZ8.212	Brake Cover Plate	1

SZ8001 Brake Adjuster Complete Repair Kit - R



VEHICLE VOLVO F10/F12/F16 - VOLVO FL10/FL12 - VOLVO BUS B10B/B10L/B12

NR	GTSA KOD	DESCRIPTION	QTY
1	GTZ8.214	Brake Adjuster C Spring	1
2	GTZ8.205	Brake Adjuster Shaft - L	1
3	GTZ8.204	Brake Adjuster Shaft - R	1
4	GTZ8.208	Brake Cross Shaft Assembly	1
5	GTZ8.215	Brake Adjuster Dirt Excluder	2

NR	GTSA KOD	DESCRIPTION	QTY
6	GTZ8.211	Brake Adjuster Strut	2
7	GTZ8.224	Brake Cover Plate Seal Kit	1
8	GTZ8.239	Brake Manual Override Kit - R (Old Model)	1
9	GTZ8.212	Brake Cover Plate	1



—
📍 Büyük Kayacık Mahallesi
3 O.S.B. Sanayi Sit. 15.Sokak No:17
Selçuklu / KONYA / TÜRKİYE

—
☎ +90 332 **239 16 64**
☎ +90 332 **239 06 98**
☎ +90 332 **239 16 63**

—
✉ info@gtsa.com.tr
🌐 www.gtsa.com.tr

